



CONNECT AND PROTECT

Flexible Conductors

(North America)

Solutions to Optimize the Design of Electrical Power and Grounding & Bonding Connections

nVent

ERIFLEX

Table of Contents

Flexible Conductors for Various Applications.....	6
Certificates	8
Product Overview.....	9
nVent ERIFLEX Flexibar Insulated Flexible Busbar	10
Accessories.....	18
Flexibar Hydraulic and Manual Workcenter.....	22
Insulated Braided Conductor (IBS/IBSB Advanced & IBSHY)	24
Grounding and Bonding Tinned Copper Braids (MBJ, MBJYG & BJ).....	35
Grounding Braid Stainless Steel Braids (CPI & CPIW).....	39
Power Shunt (PBC & PPS).....	43
Flat Copper & Stainless Steel Braids (FTCB, FRCB, FSSB & FTCBI).....	45
Round & Tubular Copper Braids (RTCB, RRCT, TTCE, RRCBI & RTCB)	46
Make Your Own Braided Connections	48
Made to Order Solutions (MTO).....	49
Cross Reference List	51

Flexible Conductors for Low-Voltage Industries

NVENT OFFERS

- A worldwide team of experts in electrical power connections
- Global solutions manufacturing
- Complete range of high-quality, reliable, certified products
- Innovative and compatible product solutions

ENERGY

- Electrical Power Generators and Distribution
 - Transformers
 - Generators
- Renewable Energies
 - Windmills
 - Solar
 - Hydropower
- Oil, Gas and Petrochemical
- Telecom
- Power Stations



TRANSPORTATION

- Marine
- Aircraft
- Ground Transportation
- Automotive



BEFORE





INDUSTRY & BUILDINGS

- Air Conditioning
- Elevators, Escalators & Automatic Doors



PANELBOARD

- Power
- Control & Command Applications:
 - Power Switchboards
 - Distribution Panel
 - UPS
 - Power Factory Correction



MACHINERY

- Tunneling
- Crushers
- Printing
- Welding
- Packaging
- Woodworking

AFTER



Flexible Conductors for Various Applications

nVent ERIFLEX is well-known for producing high quality flexible conductors for low voltage power connections. Flexible conductors made out of braids or laminates are used in a variety of applications for current transfer or grounding/earthing connections.



Worldwide certifications, applications and product availability

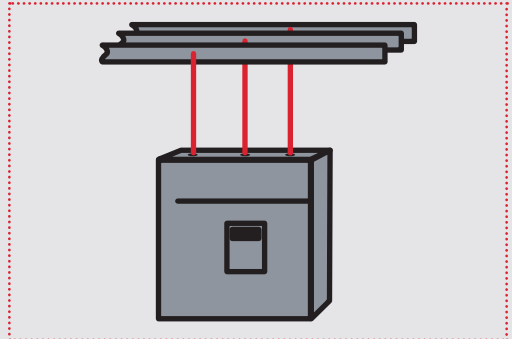

Busbar and active electrical component connections (Example: circuit breaker, contactor) including most compact components on the market

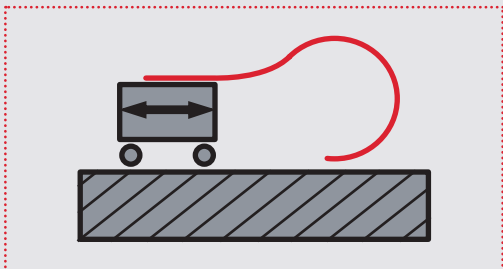

Flexible connections between fixed and moving parts

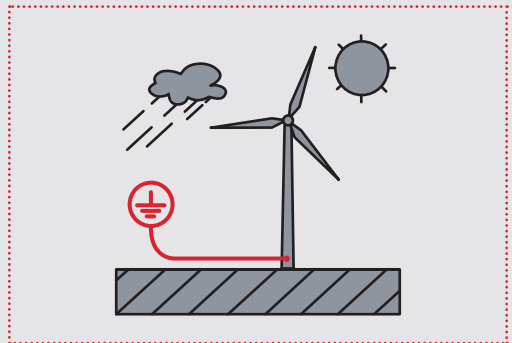

Outdoor/offshore applications or difficult environments (Example: abrasion, corrosion, UV)

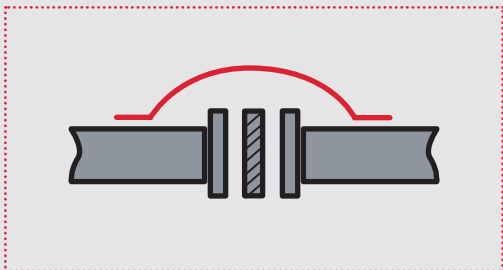

Earthing/grounding interconnections (Example: pipeline)

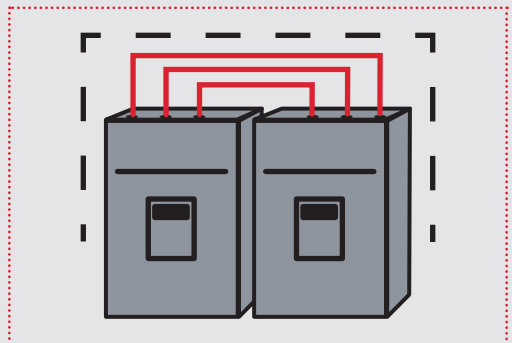

Short and compact connections between electrical components for volume reduction

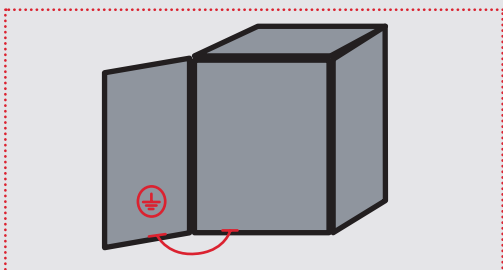

Earthing/grounding connections with excellent electro-magnetic compatibility

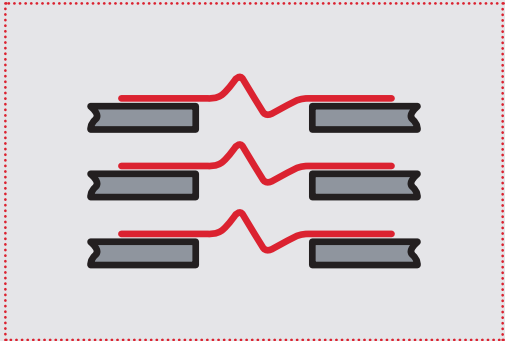

Expansion connections for busbar systems

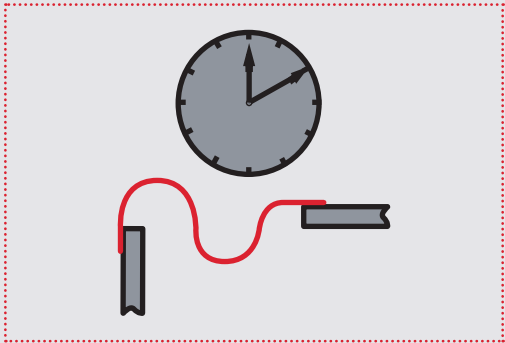

Reduce time assembly or maintenance connections

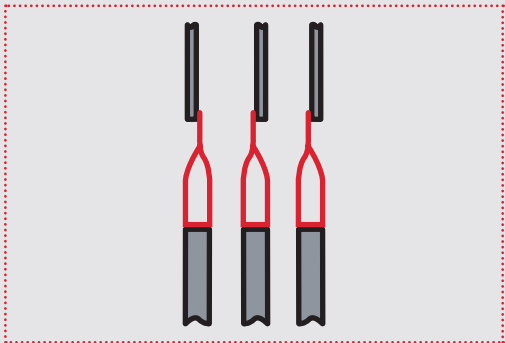

Power connections between horizontal and vertical system

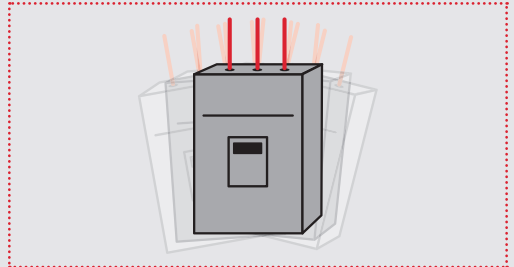

Vibration and reliability solution for connections

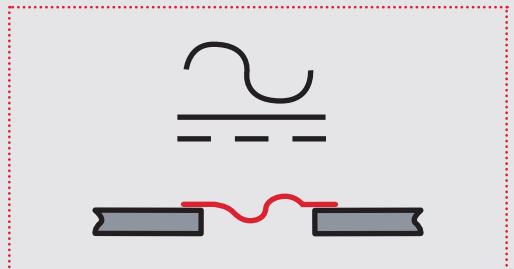

Connections for alternating current or direct current application

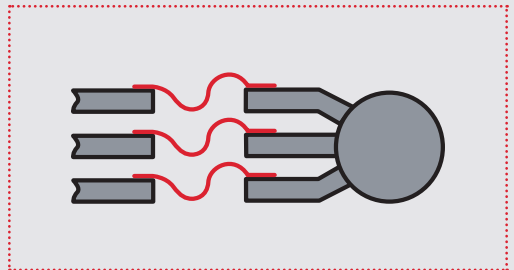

Motor, generator or transformer connections with busbar system

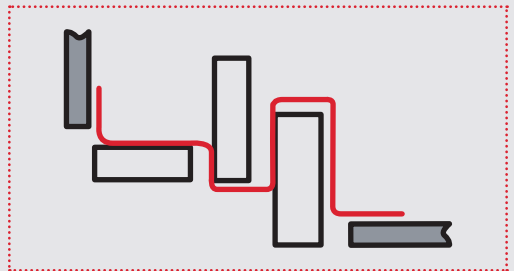

Connections everywhere

Certificates

TESTS & CERTIFICATES

nVent ERIFLEX components are compliant with several agencies and standards to meet all requirements

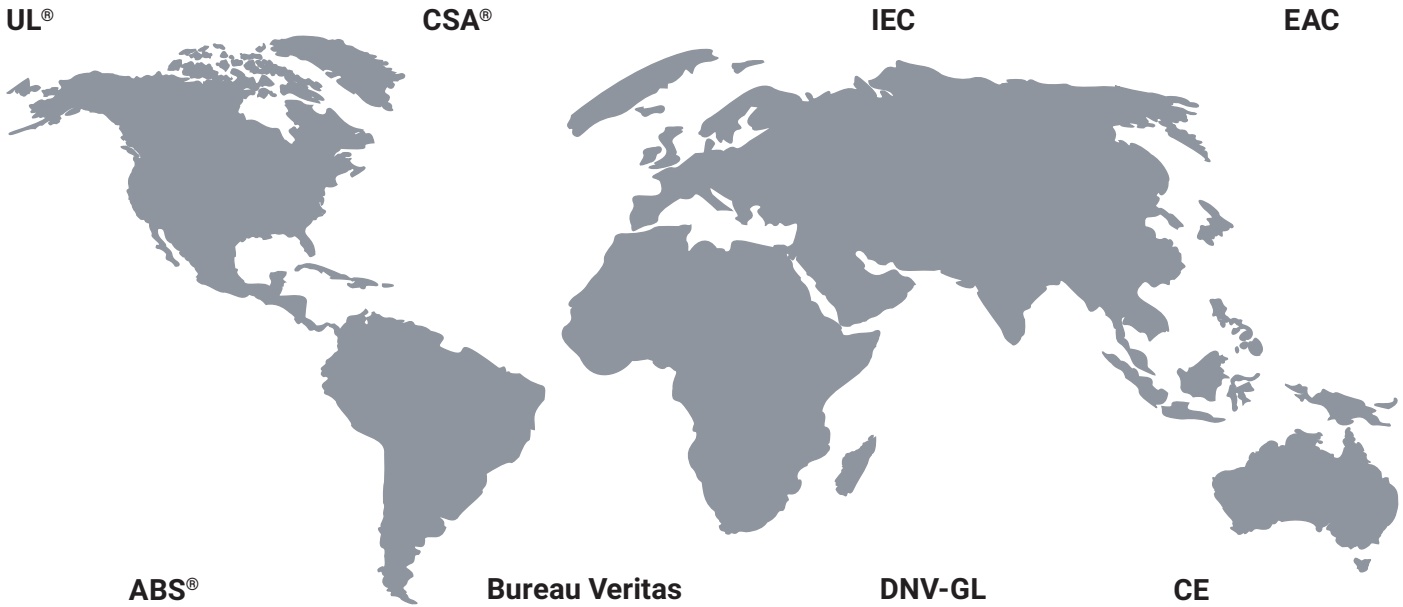

	International Electrotechnical Commission IEC 60439.1 Standard IEC 61439.1 Standard		A dedicated certification for Marine and Offshore for nVent ERIFLEX IBS/IBSB Advanced
	Underwriters Laboratories UL Recognized. File No. E125470 UL Recognized. File No. E220029 UL Recognized. File No. E316390		ABS American Bureau of Shipping Certificate No. 08-HS365878-1-PDA-DUP & Certificate No. 13-HS1018106-1-PDA-DUP Marine & Offshore Applications
	UL Listed. File No. E220029		Bureau VERITAS Certificate No. 02859 / DO BV for shipboard use
	Canadian Standards Association CSA Certified. File No. LL 90005 CSA Certified. File No 700 443 70		European Union standard fire testing to rail way components
	European Conformity		Halogen-free material as per UL and IEC
	EAC Certificate compliance for Russia		Flame retardant
	RoHS Compliant		Low smoke

Product Overview

Product Range	Typical Uses	Typical Market
nVent ERIFLEX Flexibar: Advanced, Summum 	<ul style="list-style-type: none"> • Heavy-duty power interconnection • Overcome vibration/alignment problems • Circuit breaker, generator & prefabricated power network conductor • Expansion joints • Variable terminating positions • Machine connections • Movable connection from massive busbar system • Alternative to large & multiple cables • Alternative to rigid busbar 	<ul style="list-style-type: none"> • Switchgear & control equipment • Transportation • Electrical equipment manufacturers • Power generation • Machinery manufacturing
Insulated braided conductor (IBS/IBSB Advanced & IBSHY) 	<ul style="list-style-type: none"> • Interconnects for low voltage power distribution units • IBSB specially designed for industrial circuit breaker connection • Overcome vibration/alignment problems • Battery connections • Earth/ground connections 	<ul style="list-style-type: none"> • Switchgear & control equipment • Transportation • Electrical equipment manufacturers • Power generation
Power shunt (PBC & PPS) 	<ul style="list-style-type: none"> • Transformer or generator to busbar connection • Overcome vibration/alignment problems • Power interconnection 	<ul style="list-style-type: none"> • Switchgear & control equipment • Power distribution • Transportation
Earth/ground copper braids (MBJ, MBJYG & BJ) 	<ul style="list-style-type: none"> • Power, earthing/grounding and equipotential connections • Electrical bonding enclosure door • EMI effect reduction application 	<ul style="list-style-type: none"> • Switchgear & control equipment • Rail transportation • Electrical equipment manufacturers • Power generation (wind, solar) • Data center
Earth/ground stainless steel braids (CPI & CPIW) 	<ul style="list-style-type: none"> • Earthing/grounding and equipotential connections • Superior abrasion, corrosion, chemical, and UV resistance for outdoor applications • Expansion joints • Connections for lightning protection systems 	<ul style="list-style-type: none"> • Transportation • Food and beverage industry • Power generation (wind, solar) • Chemical and oil industry • Automotive • Defense & aerospace • Civil construction • Urban projects
Flat and round copper braids in coils 	<ul style="list-style-type: none"> • Earth/ground connections • Power interconnection • Lightning protection • Flexible links • Overcome vibration/alignment problems 	<ul style="list-style-type: none"> • Defense & aerospace • Rail transportation • Automotive • Electronics • General electrical sector • Civil construction
Tubular copper braids in coils 	<ul style="list-style-type: none"> • Screening of cables from electromagnetic, electrostatic and RF interference • Mechanical support • Protection against abrasion and corrosion • EMC & EMH applications 	<ul style="list-style-type: none"> • Defense & aerospace • Transportation • Electronics & communication • Cable harness & assembly makers • Component distributors

nVent ERIFLEX Flexibar Insulated Flexible Busbar

A COMPLETE RANGE FLEXIBLE BUSBAR

- **ADVANCED**
- **SUMMUM**



ENHANCED FLEXIBILITY

nVent's exclusive manufacturing process offers superior flexibility:

- Copper laminates are free to slide within the insulation
- High insulation quality
- Wide variety of bending, twisting & folding possibilities

INNOVATIVE PATENT INSULATION

Flexibar has added grooves on the inner surface of the insulation sleeve to improve sliding between the central conductor and the insulation material. The grooves help to reduce the contact surface between the central conductor and the insulation material. This results enhances the flexibility of the flexible busbar.

Result: <20% of the inner surface is in contact with the central conductor.

This nVent ERIFLEX patent idea makes Flexibar more flexible than ever and allows users to optimize the design of their electrical power connection.

* This patent is applicable for the cross section indication by "*" on the part number.

THE REFERENCE CONDUCTOR

- nVent ERIFLEX Flexibar is composed of multiple layers of thin electrolytic copper, available in plain (Summum) or tin plated (Advanced)
- Flexibar connections are made by punching directly through the laminates. There are no lugs to purchase, which eliminates faulty connection problems and makes installation easier and faster
- The insulation is a high-resistance, self-extinguishing TPE (Flexibar Advanced), or Silicone (Flexibar Summum)
- Traceability code and designation Part Number on product
- Easily formed, Flexibar improves assembly flexibility and aesthetics of panels
- Optimal alternative to large cable & rigid busbar
- Quality: 100% production dielectric tested
- Full range from 24 mm² up to 1200 mm²

FEATURES

- Self-extinguishable/flame retardant
- High mechanical resistance
- High elongation value
- Withstands high currents
- 99.9% pure copper
- High conductivity

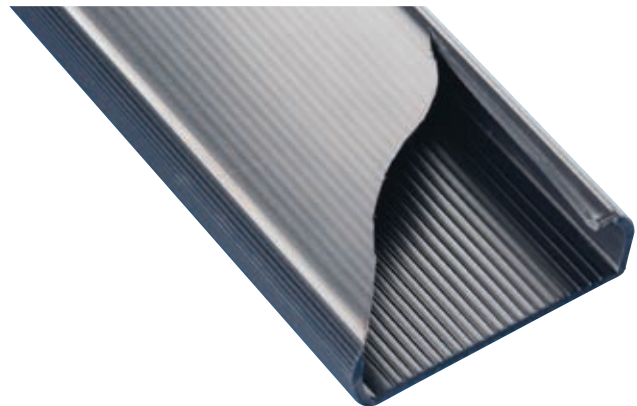

CONNECTION TYPES

- Between main power and distribution equipment (contactors, circuit-breakers)
- Between transformer and busduct
- Between busduct and electrical cabinet

SPACE/WEIGHT SAVINGS

- Less installation space compared to cable
- Reduces the length, number of conductors and weight
- Insulation allows for closer spacing than traditional busbar designs

COST SAVINGS

- Eliminates cost and installation of lugs
- Reduces inventory costs

IMPROVES RELIABILITY

- nVent ERIFLEX Flexibar is directly connected thus eliminating the cable lug connection
- Excellent resistance to vibration
- No crimping

AESTHETICS

- Optimal flexibility for easy access

EASY INSTALLATION

- Thanks to its design Flexibar can be easily bent and shaped for all sizes

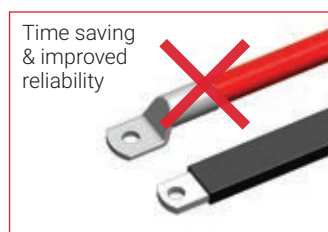
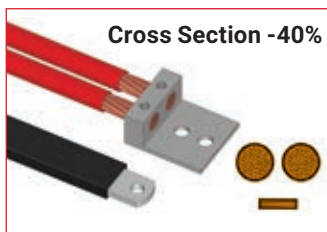
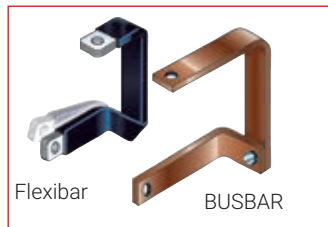
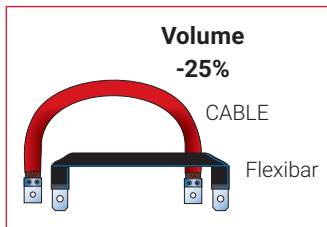

SKIN EFFECT ON A.C. APPLICATION

COPPER CABLE

FLEXIBAR



OR →

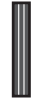

150 AMPS
1/0
5.35 sq. mm
(.373 In)

158 AMPS
3 x 9 x 0.8 mm
21.6 sq. mm
60% smaller

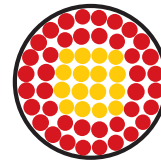

OR →



380 AMPS
500 MCM
253 sq. mm
(.813 In)

379 AMPS
3 x 24 x 1 mm
72 sq. mm
71% smaller

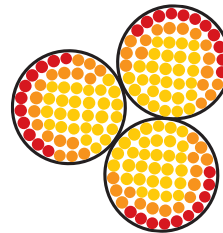

OR →



1140 AMPS
(3) 500 MCM
759 sq. mm
(.813 In)

1211 AMPS
4 x 80 x 1 mm
320 sq. mm
58% smaller

Representative to scale

Flexibar ampacity and cable ampacity are based on (NEC Table 310-16, 75° column) conductor temperature rise of 45°C

Flexibar Advanced

UNIQUE - SAFER - FLEXIBLE



FLEXIBAR ADVANCED UNIQUE – SAFER – FLEXIBLE

- Conductor is electrolytic tinned copper (Cu-ETP)
- Insulation is a high-resistance TEP Low Smoke, Halogen Free and Flame Retardant (LSHFRR) compound:
 - Typical elongation: 500%
 - Working temperature: -50°C to +115°C
 - Typical thickness: 1.8 mm
 - Self-extinguishing: UL 94 V0 and IEC 60695-2-11 (Glow Wire Test 960°C)
 - Dielectric strength: 20kV/mm
 - Nominal voltage: 1000 V AC/1500 V DC (IEC – UL - CSA)
 - Dielectric strength: 20kV/mm

WHY IS FLEXIBAR ADVANCED A SAFER INSULATION?

Low smoke features:

- Generates less corrosive smoke as per IEC 61034-2, ISO 5659-2 and UL 2885
- Improves visibility for people to be able to easily locate the emergency exit and also allows rescue workers to better assess an emergency situation

Halogen-free features:

- Reduction in the quantity of toxic smoke
- Minimum of toxicity with no halogens (according to UL 2885, IEC 60754-1 and IEC 62821-1)
- Use in enclosed spaces for specific applications such as submarines, switchboards, and other enclosed environments that require a low emissions solution



Flame-retardant and Self-extinguishing features:

- Compliant with the UL 94-V0 and Glow wire test at 960°C (IEC 60695-2) testing standard
- Reduces the risk of the spread of fire
- Less damage to your electrical installation

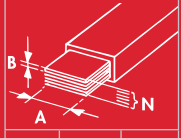

Flexibar Advanced has a unique insulation on the market that combines **low smoke, halogen-free and flame retardant** features that improve both the reliability of your electrical installation and safety for equipment and people.

FLEXIBAR ADVANCED TECHNICAL CHARACTERISTICS

Typical Application Current Rating	Part Number				Section mm ²	ΔT 20°C (A)	ΔT 30°C (A)	ΔT 35°C (A)	ΔT 40°C (A)	ΔT 45°C (A)	ΔT 50°C (A)	ΔT 60°C (A)	ΔT 65°C (A)	ΔT 70°C (A)	Current Coefficient	
		N	A mm	B mm		NEC® 310-16 60°C	NEC® 310-16 75°C	NEC® 310-16 90°C								
125 A	534001	3	9	0.8	21.6	101	126	138	148	158	167	185	193	201	1.72	2.25
	534004	3	13	0.5	19.5	102	128	139	150	160	169	187	195	203	1.72	2.25
	534006	2	15.5	0.8	24.8	121	152	166	178	190	201	222	232	241	1.72	2.25
	534005	6	13	0.5	39	150	188	205	221	235	249	275	287	299	1.72	2.25
	534002	6	9	0.8	43.2	153	192	210	226	241	255	281	293	305	1.72	2.25
250 A	534010	2	20	1	40	168	211	229	247	263	279	307	321	334	1.72	2.25
	534007	4	15.5	0.8	49.6	178	223	243	262	279	295	326	340	354	1.72	2.25
	534016	2	24	1	48	195	244	266	286	305	323	357	373	388	1.72	2.25
	534011	3	20	1	60	210	263	286	308	328	347	383	400	416	1.72	2.25
	534008	6	15.5	0.8	74.4	225	282	308	331	353	374	412	430	448	1.72	2.25
	534017	3	24	1	72	243	304	331	356	379	402	443	463	482	1.72	2.25
	534012	4	20	1	80	246	308	336	361	385	408	450	470	489	1.72	2.25
	534023	2	32	1	64	248	311	338	364	388	411	454	474	493	1.72	2.25
400 A	534013	5	20	1	100	280	351	382	411	438	464	512	535	556	1.72	2.25
	534018	4	24	1	96	285	356	388	418	445	472	520	543	565	1.72	2.25
	534030	2	40	1	80	301	376	409	440	470	497	549	573	596	1.72	2.25
	534024	3	32	1	96	308	385	419	451	481	510	562	587	611	1.72	2.25
	534014	6	20	1	120	311	390	424	457	487	516	569	594	618	1.72	2.25
	534019	5	24	1	120	322	403	439	472	504	534	589	615	640	1.72	2.25
	534020	6	24	1	144	357	448	487	524	559	592	653	682	710	1.72	2.25
	534025	4	32	1	128	359	449	489	526	561	594	655	684	712	1.72	2.25
	534031	3	40	1	120	371	464	505	544	580	614	677	707	736	1.72	2.25
	534026	5	32	1	160	405	507	552	594	633	671	740	773	804	1.72	2.25
	534015	10	20	1	200	425	532	580	624	661	704	777	811	844	1.72	2.25
	534021	8	24	1	192	424	531	578	622	663	702	775	809	841	1.72	2.25
	534032	4	40	1	160	432	541	589	633	675	715	789	824	857	1.72	2.25
	534027	6	32	1	192	448	561	611	657	701	742	819	855	889	1.72	2.25
	534037	3	50	1	150	449	562	612	658	702	743	820	856	891	1.72	2.25
	534022	10	24	1	240	484	606	660	710	757	802	885	924	961	1.72	2.25
	534033	5	40	1	200	486	608	662	712	759	804	887	926	964	1.72	2.25
800 A	534038	4	50	1	200	521	651	709	763	813	861	950	992	1032	1.72	2.25
	534028	8	32	1	256	525	657	715	770	821	869	959	1001	1042	1.72	2.25
	534034	6	40	1	240	535	669	728	784	835	885	976	1019	1061	1.72	2.25
	534039	5	50	1	250	583	730	794	855	911	965	1065	1112	1157	1.72	2.25
	534029	10	32	1	320	595	745	811	873	931	986	1088	1136	1182	1.72	2.25
	534035	8	40	1	320	628	786	855	920	981	1039	1146	1197	1246	1.72	2.25
	534044	4	63	1	252	633	792	861	927	988	1046	1155	1205	1255	1.65	2.12
	534040	6	50	1	300	641	802	873	940	1002	1061	1171	1222	1272	1.72	2.25
	534036	10	40	1	400	702	879	956	1029	1097	1162	1282	1338	1393	1.72	2.25
	534045	5	63	1	315	706	883	961	1033	1102	1167	1288	1344	1399	1.65	2.12
	534041	8	50	1	400	741	927	1009	1085	1157	1226	1352	1412	1469	1.72	2.25
1200 A	534046	6	63	1	378	772	966	1051	1130	1205	1276	1408	1470	1530	1.65	2.12
	534049	4	80	1	320	776	970	1056	1136	1211	1282	1415	1477	1538	1.65	2.12
	534042	10	50	1	500	831	1040	1132	1217	1298	1375	1517	1584	1648	1.72	2.25
	534050	5	80	1	400	861	1077	1172	1260	1344	1423	1570	1640	1706	1.65	2.12
	534047	8	63	1	504	886	1108	1205	1297	1383	1464	1616	1687	1756	1.65	2.12
	534051	6	80	1	480	938	1172	1275	1372	1463	1549	1709	1785	1858	1.65	2.12
	534048	10	63	1	630	985	1232	1341	1442	1538	1628	1797	1876	1953	1.65	2.12
1600 A	534055	5	100	1	500	1041	1301	1416	1523	1624	1719	1898	1982	2062	1.6	2.02
	534052	8	80	1	640	1073	1341	1460	1570	1674	1773	1956	2043	2126	1.65	2.12
	534056	6	100	1	600	1132	1414	1539	1655	1765	1869	2062	2153	2241	1.6	2.02
	534053	10	80	1	800	1187	1484	1614	1736	1851	1960	2164	2259	2351	1.65	2.12
	534057	8	100	1	800	1279	1598	1739	1870	1994	2111	2330	2433	2532	1.6	2.02
2000 A	534058	10	100	1	1000	1413	1765	1921	2066	2203	2332	2574	2688	2797	1.6	2.02
	534059	12	100	1	1200	1537	1920	2089	2247	2396	2537	2800	2924	3043	1.6	2.02
	534060	10	120	1	1200	1640	2049	2229	2397	2555	2706	2987	3119	3246	1.6	2.02

ADMISSIBLE CURRENTS: This table indicates the temperature rise produced by chosen current in the given section. This calculation does not take into account the heat dissipation from the switch gear.

Flexibar Advanced

UNIQUE - SAFER - FLEXIBLE

Selection of Flexibar Advanced according to the internal temperature of the panel

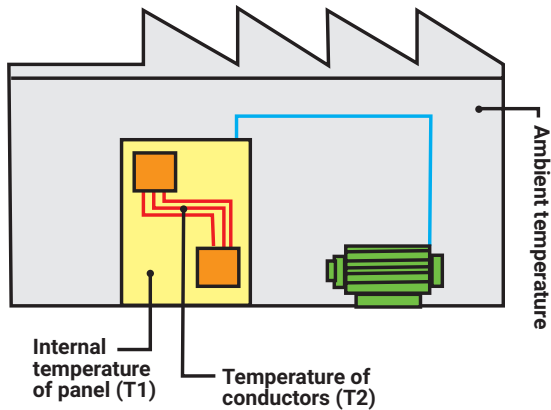

TEMPERATURE RISE OF CONDUCTOR = $T2 - T1 = \Delta T$ (K)

Ex: For a current of 630A, with: $T1 = 40^{\circ}\text{C}$ and $T2 = 90^{\circ}\text{C}$

- 1) $\Delta T = 90 - 40 = 50\text{K}$
- 2) In the 50°K column, find the closest current value to 630A. nVent ERIFLEX Flexibar Advanced 5x32x1 - 534026 - 160 mm² - 671A.
- 3) Select nVent ERIFLEX Flexibar Advanced according to the terminal width of the equipment being connected.

K = Kelvin degree (temperature calculated, but not measurable)

Flexibar Advanced IN PARALLEL

When using 2 or 3 Flexibar Advanced on edge in parallel for the same phase, use the coefficient:

Ex: $5 \times 32 \times 1: \Delta T^{\circ} = 50 \text{ K}: 671\text{A}$

2 bars in parallel: $671 \text{ A} \times 1.72 = 1154 \text{ A}$

3 bars in parallel: $671 \text{ A} \times 2.25 = 1509 \text{ A}$



CERTIFICATION & APPROVALS

- International Commission Electrotechnique (IEC) - Meets all requirements of IEC 61439.1
- UL 67 Recognized component in the Panelboard and Switchboard accessories – component category (UL file E125470) for US
- UL 758 Recognized component in the "Appliance wiring material - component" category style 11681
- CSA 90005
- CE Conformity
- RoHS compliant
- Class II Conductors (IEC 61439-1. Chapter 8.4.4 - Protection by total insulation)
- Low Smoke IEC 61034-2, ISO 5659-2 and UL 2885
- Halogen-free UL 2885, IEC 60754-1 and IEC 62821-1
- Flame retardant UL94-V0
- Glow wire test at 960°C (IEC 60695-2)
- EN 45545 obtaining an HL2 classification for chapters R22 and R23
- Bureau Veritas Marine and Offshore Division - for the Classification of Steel Ships and according IEC 60092 (Electrical installations on ships)
- American Bureau of Shipping (ABS) - Marine & Offshore Applications
- UV rating according to UL 2556 and UL 854



nVent ERIFLEX Flexibar Advanced Part Numbers

2 METERS TINNED COPPER

Part Number	Global Part Number	Flexibar Advanced Description		 Kg
534000	FADV2MTC8X6	Flexibar Advanced 2 m Tinned Copper 8X6X0.5	4	0.35
534001	FADV2MTC3X9	Flexibar Advanced 2 m Tinned Copper 3X9X0.8	4	0.43
534002	FADV2MTC6X9	Flexibar Advanced 2 m Tinned Copper 6X9X0.8	4	0.81
534003	FADV2MTC9X9	Flexibar Advanced 2 m Tinned Copper 9X9X0.8	4	1.19
534004	FADV2MTC3X13	Flexibar Advanced 2 m Tinned Copper 3X13X0.5	4	0.45
534005	FADV2MTC6X13	Flexibar Advanced 2 m Tinned Copper 6X13X0.5	4	0.79
534006	FADV2MTC2X15-5	Flexibar Advanced 2 m Tinned Copper 2X15.5X0.8	4	0.51
534007	FADV2MTC4X15-5	Flexibar Advanced 2 m Tinned Copper 4X15.5X0.8	4	1.02
534008	FADV2MTC6X15-5	Flexibar Advanced 2 m Tinned Copper 6X15.5X0.8	4	1.50
534009	FADV2MTC10X15-5	Flexibar Advanced 2 m Tinned Copper 10X15.5X0.8	4	2.20
534010	FADV2MTC2X20X1	Flexibar Advanced 2 m Tinned Copper 2X20X1	3	1.05
534011	FADV2MTC3X20X1	Flexibar Advanced 2 m Tinned Copper 3X20X1	3	1.42
534012	FADV2MTC4X20X1	Flexibar Advanced 2 m Tinned Copper 4X20X1	3	1.78
534013*	FADV2MTC5X20X1	Flexibar Advanced 2 m Tinned Copper 5X20X1	3	2.15
534014*	FADV2MTC6X20X1	Flexibar Advanced 2 m Tinned Copper 6X20X1	3	2.41
534015*	FADV2MTC10X20X1	Flexibar Advanced 2 m Tinned Copper 10X20X1	3	3.99
534016	FADV2MTC2X24X1	Flexibar Advanced 2 m Tinned Copper 2X24X1	3	1.24
534017	FADV2MTC3X24X1	Flexibar Advanced 2 m Tinned Copper 3X24X1	3	1.68
534018	FADV2MTC4X24X1	Flexibar Advanced 2 m Tinned Copper 4X24X1	3	2.12
534019*	FADV2MTC5X24X1	Flexibar Advanced 2 m Tinned Copper 5X24X1	3	2.55
534020*	FADV2MTC6X24X1	Flexibar Advanced 2 m Tinned Copper 6X24X1	3	2.99
534021*	FADV2MTC8X24X1	Flexibar Advanced 2 m Tinned Copper 8X24X1	3	3.87
534022*	FADV2MTC10X24X1	Flexibar Advanced 2 m Tinned Copper 10X24X1	3	4.75
534023	FADV2MTC2X32X1	Flexibar Advanced 2 m Tinned Copper 2X32X1	2	1.62
534024	FADV2MTC3X32X1	Flexibar Advanced 2 m Tinned Copper 3X32X1	2	2.20
534025	FADV2MTC4X32X1	Flexibar Advanced 2 m Tinned Copper 4X32X1	2	2.78
534026*	FADV2MTC5X32X1	Flexibar Advanced 2 m Tinned Copper 5X32X1	2	3.36
534027*	FADV2MTC6X32X1	Flexibar Advanced 2 m Tinned Copper 6X32X1	2	3.94
534028*	FADV2MTC8X32X1	Flexibar Advanced 2 m Tinned Copper 8X32X1	2	5.10
534029*	FADV2MTC10X32X1	Flexibar Advanced 2 m Tinned Copper 10X32X1	2	6.27
534030	FADV2MTC2X40X1	Flexibar Advanced 2 m Tinned Copper 2X40X1	2	1.99
534031	FADV2MTC3X40X1	Flexibar Advanced 2 m Tinned Copper 3X40X1	2	2.72
534032	FADV2MTC4X40X1	Flexibar Advanced 2 m Tinned Copper 4X40X1	2	3.44
534033*	FADV2MTC5X40X1	Flexibar Advanced 2 m Tinned Copper 5X40X1	2	4.16
534034*	FADV2MTC6X40X1	Flexibar Advanced 2 m Tinned Copper 6X40X1	2	4.89
534035*	FADV2MTC8X40X1	Flexibar Advanced 2 m Tinned Copper 8X40X1	2	6.33
534036*	FADV2MTC10X40X1	Flexibar Advanced 2 m Tinned Copper 10X40X1	2	7.78
534037	FADV2MTC3X50X1	Flexibar Advanced 2 m Tinned Copper 3X50X1	1	3.37
534038*	FADV2MTC4X50X1	Flexibar Advanced 2 m Tinned Copper 4X50X1	1	4.27
534039*	FADV2MTC5X50X1	Flexibar Advanced 2 m Tinned Copper 5X50X1	1	5.17
534040*	FADV2MTC6X50X1	Flexibar Advanced 2 m Tinned Copper 6X50X1	1	6.07
534041*	FADV2MTC8X50X1	Flexibar Advanced 2 m Tinned Copper 8X50X1	1	7.87
534042*	FADV2MTC10X50X1	Flexibar Advanced 2 m Tinned Copper 10X50X1	1	9.68
534044*	FADV2MTC4X63X1	Flexibar Advanced 2 m Tinned Copper 4X63X1	1	5.34
534045*	FADV2MTC5X63X1	Flexibar Advanced 2 m Tinned Copper 5X63X1	1	6.48
534046*	FADV2MTC6X63X1	Flexibar Advanced 2 m Tinned Copper 6X63X1	1	7.61
534047*	FADV2MTC8X63X1	Flexibar Advanced 2 m Tinned Copper 8X63X1	1	9.88
534048*	FADV2MTC10X63X1	Flexibar Advanced 2 m Tinned Copper 10X63X1	1	12.14
534049*	FADV2MTC4X80X1	Flexibar Advanced 2 m Tinned Copper 4X80X1	1	6.75
534050*	FADV2MTC5X80X1	Flexibar Advanced 2 m Tinned Copper 5X80X1	1	8.19
534051*	FADV2MTC6X80X1	Flexibar Advanced 2 m Tinned Copper 6X80X1	1	9.62
534052*	FADV2MTC8X80X1	Flexibar Advanced 2 m Tinned Copper 8X80X1	1	12.49
534053*	FADV2MTC10X80X1	Flexibar Advanced 2 m Tinned Copper 10X80X1	1	15.37
534055*	FADV2MTC5X100X1	Flexibar Advanced 2 m Tinned Copper 5X100X1	1	10.20
534056*	FADV2MTC6X100X1	Flexibar Advanced 2 m Tinned Copper 6X100X1	1	11.99
534057*	FADV2MTC8X100X1	Flexibar Advanced 2 m Tinned Copper 8X100X1	1	15.57
534058*	FADV2MTC10X100	Flexibar Advanced 2 m Tinned Copper 10X100X1	1	19.16
534059*	FADV2MTC12X100	Flexibar Advanced 2 m Tinned Copper 12X100X1	1	22.74
534060*	FADV2MTC10X120	Flexibar Advanced 2 m Tinned Copper 10X120X1	1	22.90

All nVent ERIFLEX Flexibar Advanced cross sections can be bent, folded or twisted with a small bending radius for shorter and more compact power connections, from 125A up to 4500A applications.



*nVent ERIFLEX Patent insulation
For other length, please contact us.

Flexibar Summum

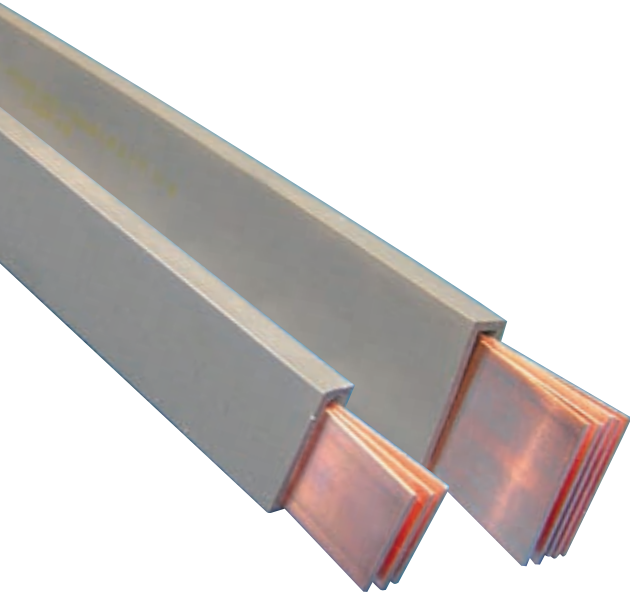

FLEXIBAR SUMMUM HALOGEN FREE - HIGH TEMPERATURE

- Halogen-free
- High current density
- High ambient temperature
- High flexibility
- High insulation value



Flexibar Summum



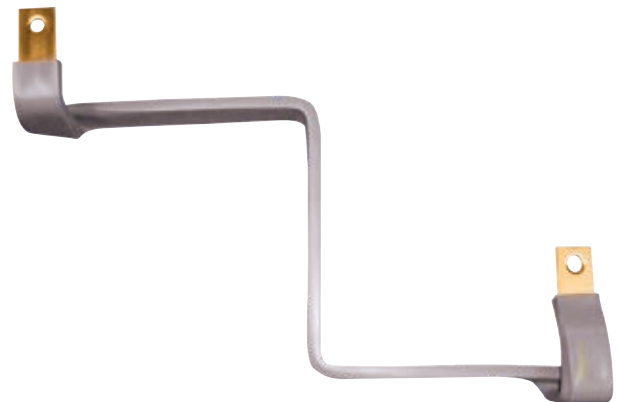
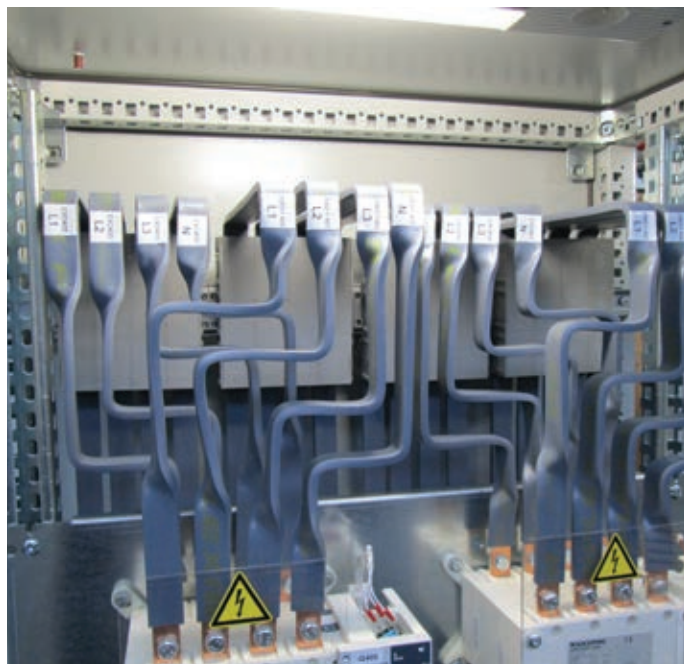

- Conductor in electrolytic copper
 - Laminates thickness 1 mm
- Insulation in silicone compound
 - Working temperature: -50°C up to 280°C (315°C short time)
 - Low smoke
 - High UV & ozone withstanding
 - Self-extinguishing: UL 94 V0
 - Elongation: 400% minimum
 - Tear resistance: 20 KN/m minimum
 - Thickness: 2 mm ± 0.2 mm
 - Dielectric strength: 20 KV/mm
 - Maximum continuous voltage: 1000 V AC/ 1500 V DC
 - American Bureau of Shipping (ABS) - Certificate No. 08-HS365878-1-PDA-DUP - Marine & Offshore Applications
 - EN 4545 obtaining an HL3 classification for chapters R22 and R23
 - IEC 60439.1
 - IEC 61439.1

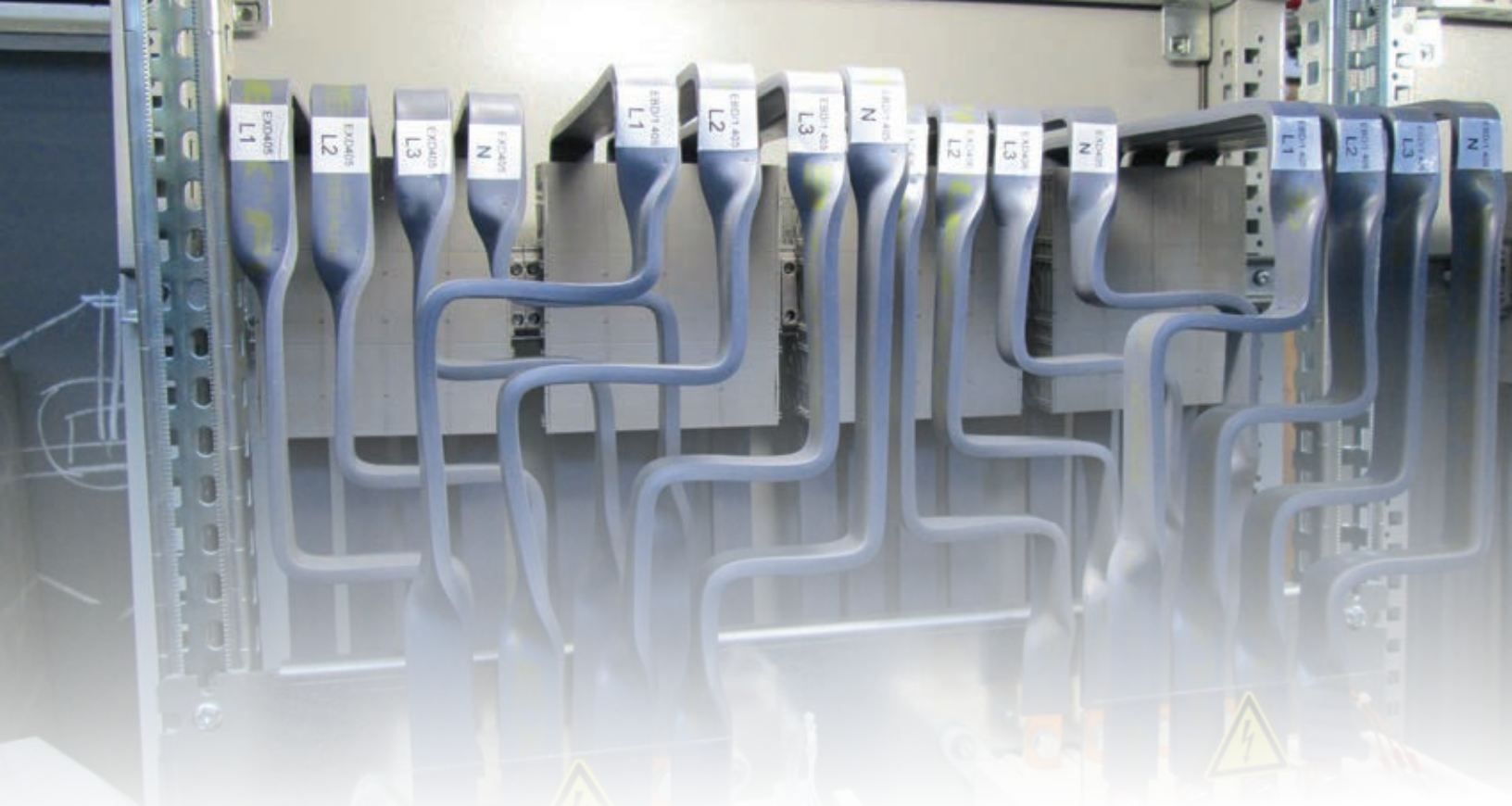
On request: Tinned Flexibar Summum





2 METER RED COPPER

Part Number	Flexibar Description		 Kg	Section mm ²	IEC [®] Ampacity ΔT (°k)					Current Coefficient	
					70	60	50	40	30		
566490	Flexibar Summum 2 M 2 x 20 x 1	5	1.05	40	326	300	275	246	214	1.72	2.25
566500	Flexibar Summum 2 M 3 x 20 x 1	5	1.42	60	428	395	360	323	280	1.72	2.25
566510	Flexibar Summum 2 M 4 x 20 x 1	5	1.78	80	476	440	402	360	312	1.72	2.25
566520	Flexibar Summum 2 M 5 x 20 x 1	5	2.15	100	498	460	420	376	326	1.72	2.25
566550	Flexibar Summum 2 M 2 x 24 x 1	5	1.24	48	450	416	380	340	295	1.72	2.25
566560	Flexibar Summum 2 M 3 x 24 x 1	5	1.68	72	490	453	413	370	320	1.72	2.25
566570	Flexibar Summum 2 M 4 x 24 x 1	5	2.12	96	550	540	465	416	360	1.72	2.25
566580	Flexibar Summum 2 M 5 x 24 x 1	5	2.55	120	608	563	514	460	398	1.72	2.25
566590	Flexibar Summum 2 M 6 x 24 x 1	5	2.99	144	670	620	566	506	438	1.72	2.25
566630	Flexibar Summum 2 M 3 x 32 x 1	5	2.2	96	570	525	480	430	372	1.72	2.25
566640	Flexibar Summum 2 M 4 x 32 x 1	5	2.78	128	648	600	548	490	425	1.72	2.25
566650	Flexibar Summum 2 M 5 x 32 x 1	5	3.36	160	758	702	640	573	496	1.72	2.25
566660	Flexibar Summum 2 M 6 x 32 x 1	5	3.94	192	846	783	715	640	555	1.72	2.25
566670	Flexibar Summum 2 M 8 x 32 x 1	5	5.1	256	1018	943	860	770	667	1.72	2.25
566720	Flexibar Summum 2 M 5 x 40 x 1	5	4.16	200	900	832	760	680	590	1.72	2.25
566730	Flexibar Summum 2 M 6 x 40 x 1	5	4.89	240	1018	943	860	770	667	1.72	2.25
566750	Flexibar Summum 2 M 10 x 40 x 1	5	7.78	400	1400	1295	1181	1055	915	1.72	2.25
566780	Flexibar Summum 2 M 5 x 50 x 1	5	5.17	250	1100	1016	930	830	718	1.72	2.25
566800	Flexibar Summum 2 M 8 x 50 x 1	2	7.87	400	1393	1290	1175	1050	912	1.72	2.25
566810	Flexibar Summum 2 M 10 x 50 x 1	2	9.68	500	1650	1525	1395	1245	1080	1.72	2.25

ADMISSIBLE CURRENTS: This table indicates the temperature rise produced by chosen current in the given section. This calculation does not take into account the heat dissipation from the switch gear.

Products not available in all locations - On Demand
Some photographs in the Flexibar Summum range may actually be using Flexibar

Accessories

END COVER 20, 24 & 32

- **End Cover 20:** Accessory for nVent ERIFLEX Flexibar 20 mm, IBS Adv 25, IBS Adv 50, IBSB Adv 50 and IBSB Adv 70.
- **End Cover 24:** Accessory for nVent ERIFLEX Flexibar 24 mm and IBSB Adv 100
- **End Cover 32:** Accessory for nVent ERIFLEX Flexibar 32 mm, IBSB Adv 120, 185 and 240
- Transparent cover visual inspection
- Halogen-free
- Self-extinguishing: UL 94 V-0
- RoHS compliant
- Easy-fitting after bolting
- IEC 60439.1
- IEC 61439.1

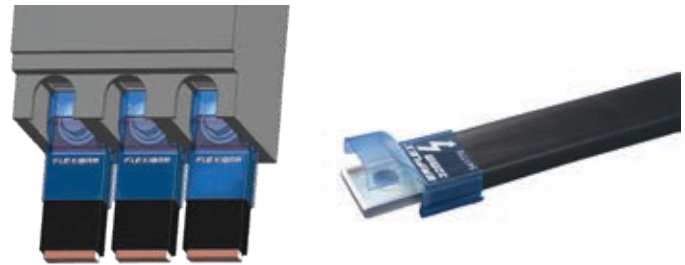

Part No.	Description		kg/lbs
541774	End Cover 20	12	0.19/0.42
541775	End Cover 24	12	0.22/0.48
541776	End Cover 32	12	0.26/0.57



SPACER CLAMPS

- Easy to install
- Fixes and maintains the weight of Flexibar range
- Facilitates cooling

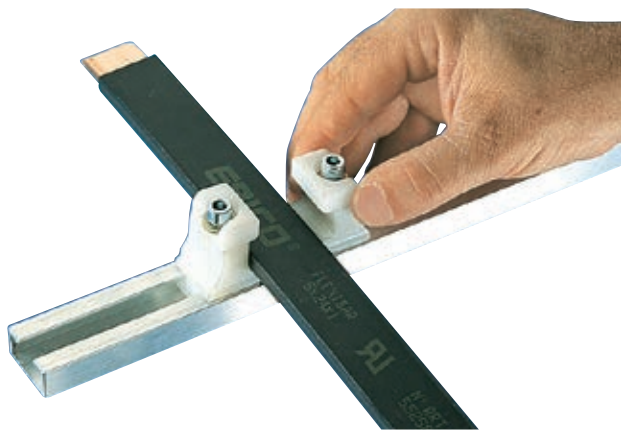

UFS KIT SUPPORT

Assembly comprised of a 2 m aluminum section and 24 retaining blocks made of glass-reinforced halogen-free polyamide.

- Possible to make up 3 supports, 650 mm long each for 4 Flexibar range
- Recommended distance between clamps: 16 inches max

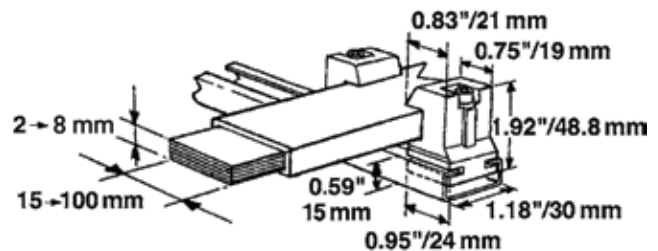

Part No.	Description		lbs
553590	UFS Kit	1	5.07





Accessories

FS

SPACER CLAMP

- Ensures correct support for Flexibar range, and IBS/IBSB Advanced in parallel, without damage to the insulation
- Maintains correct space for optimum cooling
- 4 Flexibar range in parallel maximum
- UL 67
- Recommended distance between clamps: 16 inches

Part No.	Description	Type*	H mm	L mm		 lbs
553550	FS 24	=< 24 mm	53	30	25	0.03
553560	FS 32	=< 32 mm	53	38	25	0.04
553570	FS 40-63	40-50 & 63 mm	95	150	10	2.20
553580	FS 80-100	80/100 mm	140	200	10	5.51

* Type of Flexibar and IBS/IBSB Advanced

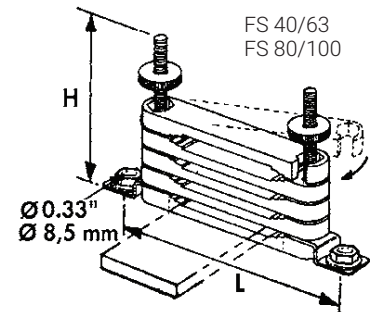
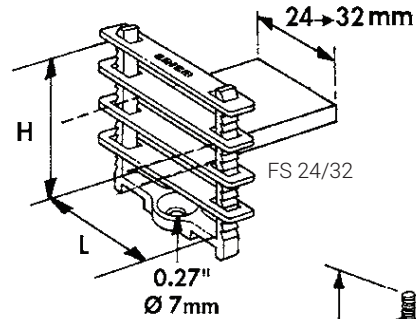

RFS

REINFORCED SUPPORT

- Allows up to 8 Flexibar range in parallel.
- Easy mounting in the panel (0.984 pitch)
- Recommended distance between clamps: 16 inches

Part No.	Description	A mm	B mm	C mm	D mm	TS	Flexibar H mm		 lbs
553370	RFS 40-63	150	175	90	120	M8	40=>63	1	2.054
553380	RFS 80-100	200	225	140	170	M10	80=>100	1	3.152

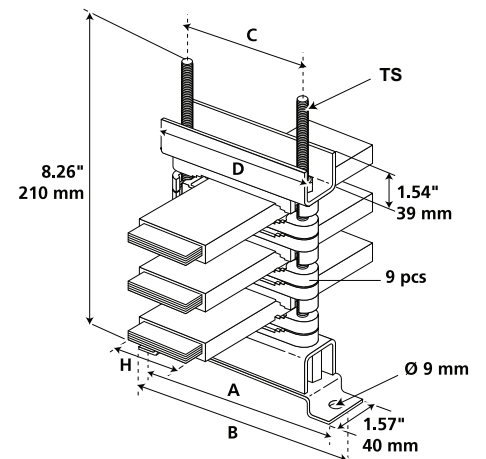

Accessories

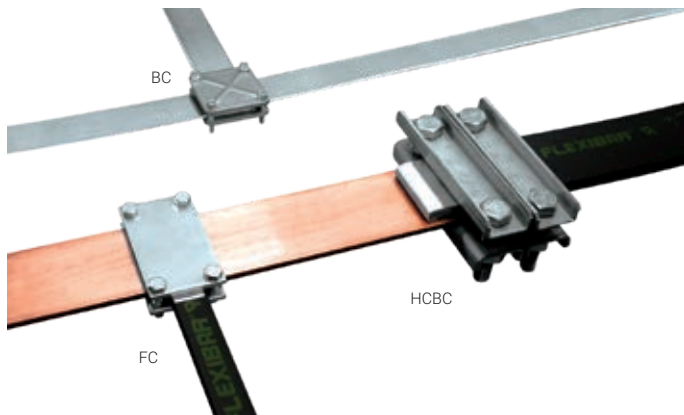

CONNECTING CLAMPS

- Excellent electrical contact
- Saves space
- Fast installation
- Ideal for on site modifications

FC

CLAMP

- Clamping capacity: 0.79 inches
- 2 zinc plated steel plates complete with M8 screws 8.8 class

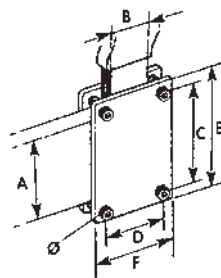

Part No.	Description	A In	B In	C In	D In	E In	F In	Torque ft/lbs	Box	lbs
553020	FC 50 x 24	2	20-24	2.32	1.42	2.95	2.05	7.37	3	0.7
553030	FC 50 x 32	2	32	2.32	1.73	2.95	2.36	7.37	3	0.8
553040	FC 50 x 40	2	40	2.32	2.05	2.95	2.68	7.37	3	0.91
553050	FC 80 x 24	3.18	20-24	3.5	1.42	4.13	2.05	7.37	3	0.95
553060	FC 80 x 32	3.18	32	3.5	1.73	4.13	2.36	7.37	3	1.08
553070	FC 80 x 50	3.18	50	3.5	2.44	4.13	3.07	7.37	3	1.41
568700	FC 100 x 32	3.97	32	4.29	1.73	4.92	2.36	7.37	3	1.47
568730	FC 120 x 32	4.4	32	5.08	1.73	5.70	2.36	7.37	3	1.67

BC

RIBBED-STEEL BUSBAR CLAMP

- Clamping capacity: 0.79 inches
- 2 ribbed zinc-plated hardened- steel plates complete with screws
- Maximum clamping capacity is 50 mm using longer screws SAE Grade 5
- UL® 67 recognized

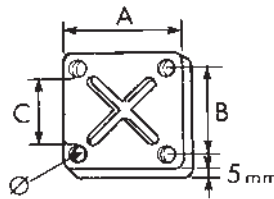

Part No.	Description	A In	B In	C In	Ø In	Torque ft/lbs	Box	lbs
553200	BC 30	2.2	1.65	1.37	M6	5.16	8	0.68
553210	BC 40	2.6	2.05	1.77	M6	5.16	8	0.81
553220	BC 50	3.26	2.52	2.16	M8	14.75	8	1.30
553230	BC 63	3.66	2.91	2.55	M8	14.75	4	1.63
553250	BC 80	4.64	3.78	3.34	M10	29.50	4	2.60
553260	BC 100	5.67	4.64	4.21	M10	29.50	4	3.79

HCBC

HIGH CURRENT BUSBAR CLAMP

- Clamping capacity: 1.58 inches
- This modular busbar clamp is designed with non-magnetic materials for high current connections between Flexibar and rigid busbars such as transformer terminals
- Design assures rigidity and even contact pressure
- Use 2 clamps to guarantee the contact pressure

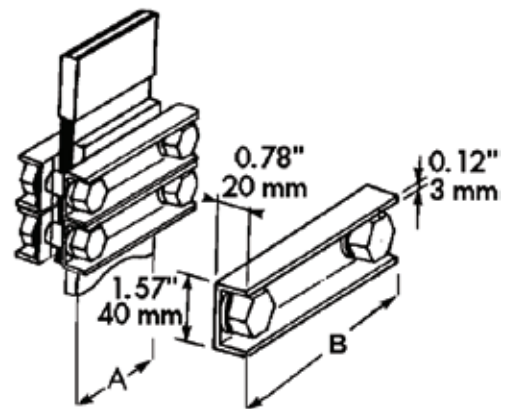

Part No.	Description	A In	B In	Torque ft/lbs	Box	lbs
553100	HSBC 80	3.15	5.5	74	1	1.85
553110	HSBC 100	3.94	6.3	74	1	2.03
553120	HSBC 120	4.72	7.2	74	1	2.20

Accessories



FBC

CONNECTORS FOR CONNECTING WITHOUT DRILLING

- No need to drill to a 5 mm or 10 mm thick busbar
- Cables from 1 mm² up to 185 mm² or Flexibar range width 6 mm to 20 mm
- Self-support of connector during mounting procedure
- IEC 60 999

NVENT ERIFLEX FLEXIBAR TYPE

Connectors for busbar thickness 5 mm

Part No.	Description	A mm	B mm	C mm	Flexibar Type (mm)	Torque N.m	Cable Size mm ²		Kg
553405	FBC 5 x 4	23	29	11	-	2	1 - 4	15	0.016
553400	FBC 5 x 6	28	31	14	6	3	2.5 - 16	15	0.028
553410	FBC 5 x 9	36	40	19	9	6-8	16 - 50	15	0.068
553510	FBC 5 x 15.5	44	40	25	15.5	10-12	35 - 70	15	0.110
553520	FBC 5 x 20	48	40	31	20	12-15	70 - 185	15	0.132

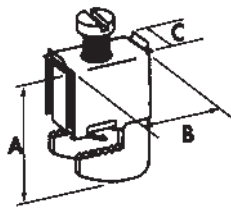

Connectors for busbar thickness 10 mm

Part No.	Description	A mm	B mm	C mm	Flexibar Type (mm)	Torque N.m	Cable Size mm ²		Kg
553505	FBC 10 x 4	28	29	12	-	2	1 - 4	15	0.018
553430	FBC 10 x 6	33	31	14	6	3	2.5 - 16	15	0.030
553440	FBC 10 x 9	42	40	19	9	6 - 8	16 - 50	15	0.070
553530	FBC 10 x 15.5	49	40	25	15.5	10 - 12	35 - 70	15	0.112
553540	FBC 10 x 20	54	40	31	20	12 - 15	70 - 185	15	0.138

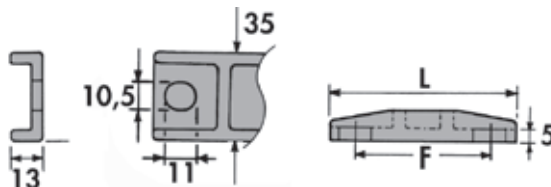

QCC

CLAMPS

- For Flexibar thickness < 5 mm = 1 clamp
- For Flexibar thickness > 5 mm = 2 clamps

Part No.	Description	Flexibar width		L mm	F mm		Kg
		min. mm	max. mm				
561210	QCC 15.5/32	15.5	32	70	50	5	0.112
561220	QCC 40/63	40	63	95	75	5	0.158

Flexibar Hydraulic Workcenter



To discover our full range of tools,
please request our Hydraulic & Manual
Tools brochure



Hydraulic Busbar &
Flexibar Puncher



Hydraulic Busbar Bender



Hydraulic Busbar Cutter



Shearing Tool Ruler



Hydraulic Pump & Foot
Controller



Hydraulic Flexibar
Shearing Tool



Shearing Tool Guide

Flexibar Manual Workcenter

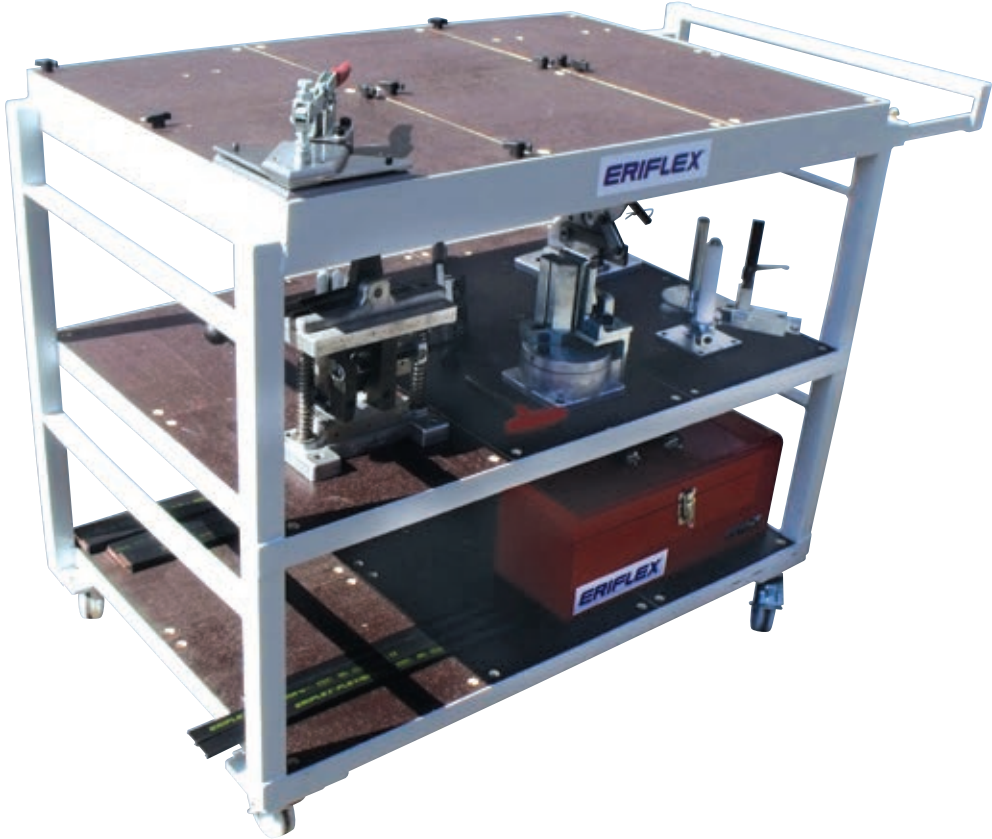

Shearing Tool



Twisting Tool



Bending Tool



Drilling Tool



Punching Tool



Folding Tool



Stripping Tool



Stripping Knife



Bending Tool

Insulated Braided Conductor (IBS/IBSB Advanced)

HALOGEN-FREE - LOW SMOKE - FLAME RETARDANT INSULATED BRAIDED CONDUCTOR FOR CIRCUIT BREAKERS



SPACE AND WEIGHT ADVANTAGE

- nVent ERIFLEX IBS & IBSB Advanced require less wire bending space than traditional cable with greater flexibility
- With greater ampacities, a single piece of IBS & IBSB Advanced can replace multiple runs of cable
- Protective sleeve and flexibility allows IBS & IBSB Advanced to be mounted in tight areas where rigid busbar or rigid cables can not be used
- No clearance distance needed around IBS & IBSB Advanced vs other phases or metallic parts due to Class II insulation characteristics
- Integral solid palm without lugs or terminals reduces material and assembly weight

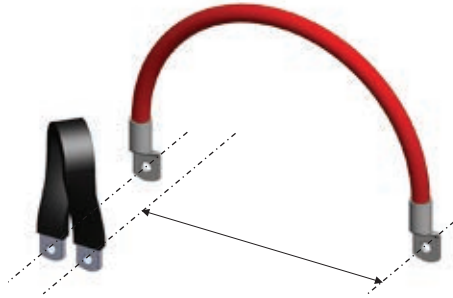

TIME ADVANTAGE

- IBS & IBSB Advanced is a ready to use conductor that does not require lug or tools to fabricate the conductor, reducing installation time and cost
- Easier to bend and shape than large cables, making installation quicker



AESTHETIC ADVANTAGE

- Increases design flexibility
- Neatly organizes hard-to-make connections

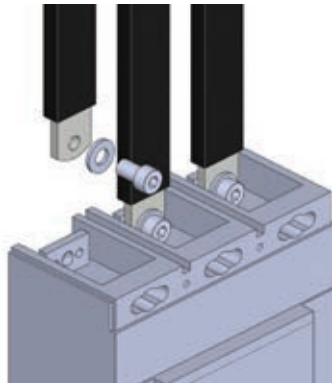

RELIABILITY & SAFETY ADVANTAGE

- IBS & IBSB Advanced are directly connected thus eliminating the cable lug connection and other source of heating point
- IBS & IBSB Advanced have tinned protected palms for better corrosion resistance
- Excellent resistance to vibration
- No crimping
- Less human error
- Insulation sleeve manufactured from high-resistance low smoke, halogen-free and flame retardant Thermoplastic (LSHFFR), with a 115°C maximum temperature



OPERATING ADVANTAGE

- IBS & IBSB Advanced are able to connect on the front access connection of the main molded case circuit breakers
- Ring terminals or lugs are no longer needed as IBS & IBSB Advanced is already punched. No additional crimping operation is needed
- The high working temperature 115°C is better than a standard cable that allow reducing the risk of hot point at the connecting area





NVENT ERIFLEX ADVANCED TECHNOLOGY INSULATION IS A HIGH-RESISTANCE LOW SMOKE, HALOGEN-FREE AND FLAME RETARDANT THERMOPLASTIC (LSHFFR), WITH 115°C HIGH WORKING TEMPERATURE.

IBS & IBSB Advanced does not generate corrosive gases and produces a relatively low smoke opacity in accordance with IEC 61034-2 and UL 2885. The **low smoke** features improves visibility conditions for people to be able to easily locate the emergency exit and also allows rescue workers to better assess an emergency situation. IBS & IBSB Advanced means greater safety for individuals, less damage for your electrical equipment and less environmental impact.

The **halogen-free** feature enables a reduction in the quantity of toxic smoke. IBS & IBSB Advanced contain no halogens, according to IEC 60754-1 and UL 2885, minimizing toxicity and making it the ideal product for use in enclosed spaces such as data centers, rail and spaces where people are present such as hospitals and schools. This feature also facilitates the use of IBS & IBSB Advanced in specific applications such as submarines, switchboards and other enclosed environments that require a low emissions solution.

In addition to the above features, IBS & IBSB Advanced are compliant with the UL 94-V0 testing standard and Glow wire test 960°C. The **flame retardant** portion of the test illustrates self-extinguishing capabilities. This feature is also shown by the Limiting Oxygen Index (LOI) at 30%. In the case of a fire, IBS & IBSB Advanced generates a limited quantity of smoke that is less damaging to your electrical equipment.











Main Technical Specifications

Flat IBS and IBSB Advanced	
Material	Electrolytic copper Cu-ETP 99,9% purity Thermoplastic Elastomer
Wire Diameter	0,15 mm
Finish	Tinned
Maximum resistivity at 20°C	0.017241 ohms.mm ² / m
Dielectric Strength	20 kV/mm
Flammability Rating	UL® 94V-0 IEC® 60695-2-12 (Glow Wire Test 960°C)
Halogen Free Rating	UL® 2885 IEC® 60754-1 IEC® 62821-2
Low Smoke Rating	UL® 2885 IEC® 61034-2 ISO 5659-2
Typical Insulation Elongation	> 500%
Typical Insulation Thickness	1.8 mm (0,070 inches)
Nominal Voltage	UL/IEC: 1,000 VAC; 1,500 VDC
Working Temperature	-50 to 115°C (-58 to 239°F)
Certification Details	UL® 67 UL® 758 CSA 90005
Complies With	IEC® 60695-2-12 (Glow Wire Test 960°C) IEC® 61439.1 IEC® 61439.1 Class II UV rating according to UL 2556 and UL 854 CE RoHS EN 45545 : HL2 classification Marine & Offshore application certified by : DNV-GL, Bureau Veritas, ABS



Dimension and Packing Unit

Use with Circuit Breaker	Part Number	Article Number	Cross Section mm ²	Conductor Width mm	Conductor Thickness mm	L mm	A mm	B mm	C mm	D mm	HS1 mm	HS2 mm	
	IBSBADV25-230	534400	25	12	2.8	230	7.5	7.5	18	9	6.5	6.5	10
	IBSBADV25-330	534401	25	12	2.8	330	7.5	7.5	18	9	6.5	6.5	10
	IBSBADV25-430	534402	25	12	2.8	430	7.5	7.5	18	9	6.5	6.5	10
	IBSBADV25-530	534403	25	12	2.8	530	7.5	7.5	18	9	6.5	6.5	10
	IBSBADV25-630	534404	25	12	2.8	630	7.5	7.5	18	9	6.5	6.5	10
	IBSBADV25-830	534405	25	12	2.8	830	7.5	7.5	18	9	6.5	6.5	10
	IBSBADV25-1030	534406	25	12	2.8	1030	7.5	7.5	18	9	6.5	6.5	10
	IBSADV25-230	534500	25	20	1.9	230	10	12	25	6	8.5	10.5	10
	IBSADV25-330	534501	25	20	1.9	330	10	12	25	6	8.5	10.5	10
	IBSADV25-430	534502	25	20	1.9	430	10	12	25	6	8.5	10.5	10
	IBSADV25-530	534503	25	20	1.9	530	10	12	25	6	8.5	10.5	10
	IBSADV25-630	534504	25	20	1.9	630	10	12	25	6	8.5	10.5	10
	IBSADV25-830	534505	25	20	1.9	830	10	12	25	6	8.5	10.5	10
	IBSADV25-1030	534506	25	20	1.9	1030	10	12	25	6	8.5	10.5	10
	IBSBADV50-230	534407	50	20	3	230	9	11	27	9	8.5	10.5	10
	IBSBADV50-330	534408	50	20	3	330	9	11	27	9	8.5	10.5	10
	IBSBADV50-430	534409	50	20	3	430	9	11	27	9	8.5	10.5	10
	IBSBADV50-530	534410	50	20	3	530	9	11	27	9	8.5	10.5	10
	IBSBADV50-630	534411	50	20	3	630	9	11	27	9	8.5	10.5	10
	IBSBADV50-830	534412	50	20	3	830	9	11	27	9	8.5	10.5	10
	IBSBADV50-1030	534413	50	20	3	1030	9	11	27	9	8.5	10.5	10
	IBSADV50-230	534507	50	20	3.8	230	12	12	25	7.5	10.5	10.5	10
	IBSADV50-330	534508	50	20	3.8	330	12	12	25	7.5	10.5	10.5	10
	IBSADV50-430	534509	50	20	3.8	430	12	12	25	7.5	10.5	10.5	10
	IBSADV50-530	534510	50	20	3.8	530	12	12	25	7.5	10.5	10.5	10
	IBSADV50-630	534511	50	20	3.8	630	12	12	25	7.5	10.5	10.5	10
	IBSADV50-830	534512	50	20	3.8	830	12	12	25	7.5	10.5	10.5	10
	IBSADV50-1030	534513	50	20	3.8	1030	12	12	25	7.5	10.5	10.5	10
	IBSBADV70-230	534414	70	20	4.3	230	9	11	27	11	8.5	10.5	10
	IBSBADV70-330	534415	70	20	4.3	330	9	11	27	11	8.5	10.5	10
	IBSBADV70-430	534416	70	20	4.3	430	9	11	27	11	8.5	10.5	10
	IBSBADV70-530	534417	70	20	4.3	530	9	11	27	11	8.5	10.5	10
	IBSBADV70-630	534418	70	20	4.3	630	9	11	27	11	8.5	10.5	10
	IBSBADV70-830	534419	70	20	4.3	830	9	11	27	11	8.5	10.5	10
	IBSBADV70-1030	534420	70	20	4.3	1030	9	11	27	11	8.5	10.5	10
	IBSBADV100-230	534421	100	24	5	230	9	11	31	13	8.5	10.5	10
	IBSBADV100-330	534422	100	24	5	330	9	11	31	13	8.5	10.5	10
	IBSBADV100-430	534423	100	24	5	430	9	11	31	13	8.5	10.5	10
	IBSBADV100-530	534424	100	24	5	530	9	11	31	13	8.5	10.5	10
	IBSBADV100-630	534425	100	24	5	630	9	11	31	13	8.5	10.5	10
	IBSBADV100-830	534426	100	24	5	830	9	11	31	13	8.5	10.5	10
	IBSBADV100-1030	534427	100	24	5	1030	9	11	31	13	8.5	10.5	10
	IBSBADV120-230	534428	120	32	4.4	230	11	11	39	12	10.5	10.5	2
	IBSBADV120-330	534429	120	32	4.4	330	11	11	39	12	10.5	10.5	2
	IBSBADV120-430	534430	120	32	4.4	430	11	11	39	12	10.5	10.5	2
	IBSBADV120-530	534431	120	32	4.4	530	11	11	39	12	10.5	10.5	2
	IBSBADV120-630	534432	120	32	4.4	630	11	11	39	12	10.5	10.5	2
	IBSBADV120-830	534433	120	32	4.4	830	11	11	39	12	10.5	10.5	2
	IBSBADV120-1030	534434	120	32	4.4	1030	11	11	39	12	10.5	10.5	2
	IBSBADV185-330	534435	185	32	7.1	330	12	14	39	16	10.5	12.5	2
	IBSBADV185-430	534436	185	32	7.1	430	12	14	39	16	10.5	12.5	2
	IBSBADV185-530	534437	185	32	7.1	530	12	14	39	16	10.5	12.5	2
	IBSBADV185-630	534438	185	32	7.1	630	12	14	39	16	10.5	12.5	2
	IBSBADV185-830	534439	185	32	7.1	830	12	14	39	16	10.5	12.5	2
	IBSBADV185-1030	534440	185	32	7.1	1030	12	14	39	16	10.5	12.5	2
	IBSBADV240-330	534441	240	32	9.2	330	12	14	39	18.5	10.5	12.5	2
	IBSBADV240-430	534442	240	32	9.2	430	12	14	39	18.5	10.5	12.5	2
	IBSBADV240-530	534443	240	32	9.2	530	12	14	39	18.5	10.5	12.5	2
	IBSBADV240-630	534444	240	32	9.2	630	12	14	39	18.5	10.5	12.5	2
	IBSBADV240-830	534445	240	32	9.2	830	12	14	39	18.5	10.5	12.5	2
	IBSBADV240-1030	534446	240	32	9.2	1030	12	14	39	18.5	10.5	12.5	2

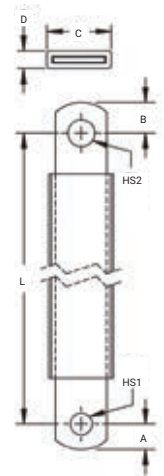

How to select nVent ERIFLEX IBS & IBSB Advanced

When sizing a conductor, the air temperature around the conductor is a very important parameter, mainly affected by factors such as convection type, protection level of enclosure or the temperature rise. Based on IEC 61439 standards, the ambient air temperature does not exceed +40°C and its average over a period of 24h does not exceed +35°C.

For IBS & IBSB Advanced, we provided an ampacity table under different temperature rise, a lower temperature rise maybe used when the ambient temperature is higher than usual.

For IBS & IBSB Advanced, we recommend the maximum temperature rise does not exceed 50°C for a normal application. Generally, 50°C is chosen as the default temperature rise considering the ambient temperature inside the panel is below 40°C. But when the connected section is an electrical component which may dissipate heat (for example circuit breaker) or the ventilation inside the enclosure is not efficient, it may be necessary to choose lower temperature rise.

TEMPERATURE RISE OF THE CONDUCTOR.

Temperature rise of the conductor (ΔT) = Temperature of the conductor – Internal temperature of the panel

• Temperature rise of conductor = $T_2 - T_1 = \Delta T$ (C°)

Example:

For a requested current of 630A, with: $T_1 = 40^\circ\text{C}$ and $T_2 = 90^\circ\text{C}$

• $\Delta T = 90 - 40 = 50^\circ\text{C}$

• in the ΔT 50°C column, find the closest current value to 630A

Result: IBSB Advanced 240 mm² – 718A (IEC & UL)

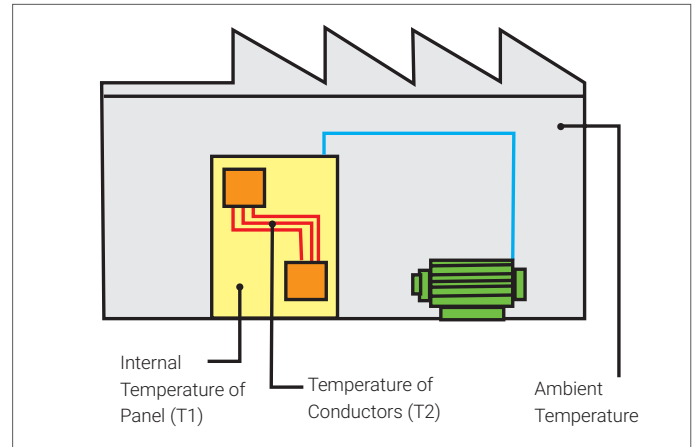

Insulated Braided conductor type	Cross Section mm ² (kcmil)	Maximum Ampacity Ratings							Current Coefficient	
		ΔT 30° C (A)	ΔT 40° C (A)	ΔT 45° C (A)	ΔT 50° C (A)	ΔT 55° C (A)	ΔT 60° C (A)	ΔT 70° C (A)		
IBSB ADV 25	25 (49.34)	116	134	142	150	157	164	177	1.6	2
IBS ADV 25	25 (49.34)	137	158	167	177	185	193	209	1.6	2
IBS ADV 50 IBSB ADV 50	50 (98.68)	213	246	260	274	288	301	325	1.6	2
IBSB ADV 70	70 (138.15)	226	261	277	291	306	319	345	1.6	2
IBSB ADV 100	100 (197.35)	298	344	365	385	404	422	456	1.6	2
IBSB ADV 120	120 (236.82)	363	419	444	468	491	513	554	1.6	2
IBSB ADV 185	185 (365.1)	416	480	509	537	563	588	635	1.6	2
IBSB ADV 240	240 (473.65)	556	642	681	718	753	786	849	1.6	2

Admissible currents: This table indicates the temperature rise produced by chosen current in the given section. This calculation does not take into account the heat dissipation from the switch gear.

IBS & IBSB ADVANCED IN PARALLEL

When using 2 or 3 IBS & IBSB Advanced in parallel for the same phase, use the current coefficient showed on the above IEC & UL ampacities table.

Example:

IBSB Advanced 240 mm² – $\Delta T = 50^\circ\text{C}$: 718 A (IEC & UL)

- 2 Braids in parallel: 718 A x 1,6 = 1149 A
- 3 Braids in parallel: 718 A x 2 = 1436 A

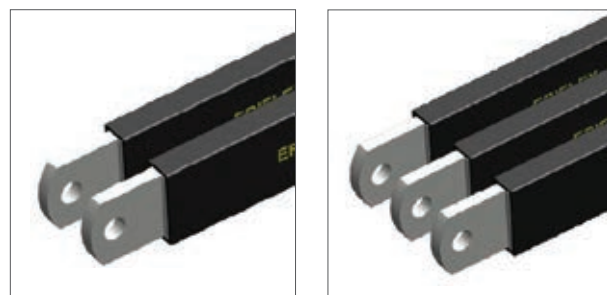

IBS & IBSB Advanced Connection on Molded Case Circuit Breaker

The IBS & IBSB Advanced range can be used as an alternative to cable for all low-voltage applications. It is suitable and connectable for molded case circuit breaker ranges, including most compact breakers on the market. From 80A up to 630A circuit breakers, you can directly connect the IBS & IBSB Advanced on the front access terminals breaker without additional accessories, such as angular connectors, spreaders, ring terminal connectors or extenders. No lugs and no cutting, stripping or crimping are necessary.

Simple, quick, ready to use!

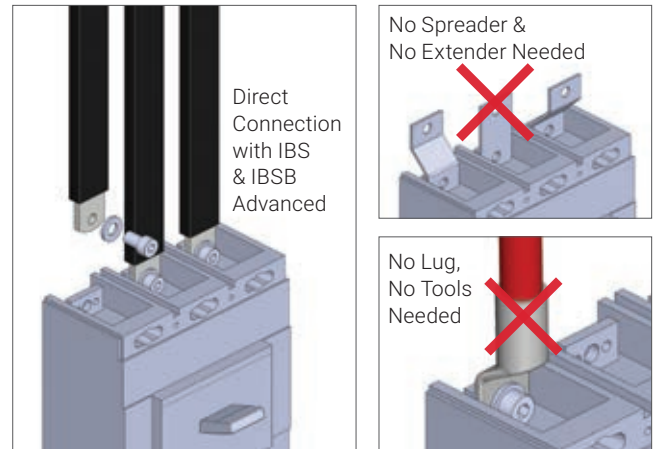

CIRCUIT BREAKER COMPATIBILITY

Circuit Breaker Current Rating	125/160 A		250 A		300 A	350 A	400 A	500 A	630 A
Insulated Braided conductor type	IBSB ADV 25x	IBS ADV 25x	IBSB ADV 50x	IBS ADV 50x	IBSB ADV 70x	IBSB ADV 100x	IBSB ADV 120x	IBSB ADV 185x	IBSB ADV 240x
Schneider Electric Compact (IEC)	NSA NG 125	NSX 100 NSX 160	NSX 250	NSX 250	NSX 400	NSX 400	NSX 400	NSX 630	NSX 630
Square D PowerPact (UL)	H-Frame	J-Frame	J-Frame	J-Frame	L-Frame	L-Frame	L-Frame	-	-
ABB Tmax (IEC)	T1 T2 XT1 XT2	-	T3 XT3 XT4	T3 XT3 XT4	T4	T4	T5	T5	T5
ABB Tmax (UL)	T1 T2 XT1 XT2	T3	T4 XT3 XT4	T4 XT3 XT4	T5	T5	T5	-	-
GE Record Plus (IEC/UL)	FD 160	FE 160	FE 250	FE 250	FG 400	FG 400	FG 400	FG 630	FG 630
Siemens Sentron (IEC/UL)	VL160X 3VL1 VL160 3VL2	-	VL250 3VL3	VL250 3VL3	VL400 3VL4	VL400 3VL4	VL400 3VL4	-	-
Moeller xEnergy (IEC)	NZM1		NZM2	NZM2	NZM3	NZM3	NZM3	NZM3	NZM3
Cutler Hammer Series G (UL)	EG Frame	JG Frame	JG Frame	JG Frame	LG Frame	LG Frame	LG Frame	LG Frame	LG Frame
Legrand (IEC)	DPX 160 DPX3 160	-	DPX 250 DPX3 250	DPX 250 DPX3 250	DPX 630	DPX 630	DPX 630	DPX 630	DPX 630
Hager (IEC)	h3 160	-	h3 250	h3 250	h3 630	h3 630	-	-	-
Rockwell/Allen Bradley (UL)	G-Frame H-Frame	-	I-Frame J-Frame	I-Frame J-Frame	I-Frame J-Frame	-	K-Frame	K-Frame	-
Mitsubishi Electric (IEC)	-	NF125 NF160 DSN125 DSN160	NF250 DSN250	NF250 DSN250	-	NF400 DSN400	-	-	-
OEZ (IEC)	BC160N	-	BD250N BD250S	BD250N BD250S	BH630B BH630S	BH630B BH630S	BH630B BH630S	BH630B BH630S	BH630B BH630S

This table does not take into account the specific installation environment, like ambient temperature, protection level of enclosure, altitude, frequency. Some MCCB may need more important cross section in function of the MCCB Power dissipation. In some cases, increasing the IBS & IBSB Advanced cross section may be necessary to support MCCB heating dissipation. It is therefore necessary to respect the instructions provided by the electrical device manufacturer.

Round Insulated Braided Conductor IBS Advanced

IBS 120
IBS 185
IBS 240



INSULATION

- Dielectric Strength: 20 kV/mm
- Insulation Elongation: 500 %
- Insulation Thickness: 1.8 mm
- Max Working Voltage, IEC/UL 758: 1,000 VAC; 1,500 VDC
- Max Working Voltage, UL 67: 600 VAC/DC
- Working Temperature: -50 to 115°C
- Certification Details: UL® 67; UL® 758
- Complies With: IEC® 60695-2-11 (Glow Wire Test 960°C); IEC® 61439.1; IEC® 61439.1 Class II
- UV rating according to UL 2556 and UL 854

BRAID

- Tinned electrolytic copper for better corrosion protection
- Wire diameter: 0.15 mm for maximum flexibility

CERTIFICATION & APPROVAL

- Flammability Rating: UL® 94V-0
- Halogen Free Rating: UL® 2885; IEC® 60754-1; IEC® 62821-1
- Low Smoke Rating: IEC® 61034-2; ISO 5659-2; UL® 2885
- IEC 61439.1
- cRUus per UL67 & CAN/CSA C22.2 No. 29
- CE conformity
- RoHS compliant
- RU per UL758
- American Bureau of Shipping (ABS) Bureau Veritas : Marine & Offshore application.
- CSA C22.2 No 210 for appliance wiring material products
- Conforms to NF EN 45545 obtaining an HL2 classification for chapters R22 and R23

DIELECTRIC TEST

- 3500 VAC, 1 minute according to the IEC 61439 standard (rated insulation voltage U_i 1000 VAC)
- 6000 VAC, 1 minute with 6 mA creepage current set up

FEATURES

- Resistant to vibration, improving reliability and performance
- Insulated by high-resistance, halogen free, flame retardant and low smoke material
- Tinned copper provides superior corrosion resistance
- Improves assembly flexibility and aesthetics
- Quick and easy installation
- No additional cutting, stripping, crimping and punching needed

TECHNICAL DATA

- Intensity = 100A up to 1000A
- Excellent electrical contact
- Good tensile strength



Round Insulated Braided Conductor IBS Advanced

IBS 120
IBS 185
IBS 240

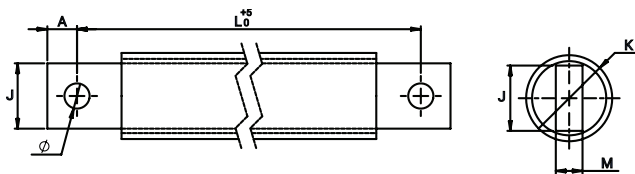

	Part No.	IBS 120	S mm ²	L mm	Ø mm	A mm	J mm	M mm	K mm		Kg
400 A	534514	IBS 120-330-10	120	330	10,5	12	24	10	27	2	0,51
	534515	IBS 120-430-10	120	430	10,5	12	24	10	27	2	0,67
	534516	IBS 120-530-10	120	530	10,5	12	24	10	27	2	0,82
	534517	IBS 120-630-10	120	630	10,5	12	24	10	27	2	0,98
	534518	IBS 120-830-10	120	830	10,5	12	24	10	27	2	1,29
	534519	IBS 120-1030-10	120	1030	10,5	12	24	10	27	2	1,6

	Part No.	IBS 185	S mm ²	L mm	Ø mm	A mm	J mm	M mm	K mm		Kg
500 A	534520	IBS 185-330-10	185	330	10,5	12	24	15	31	2	0,82
	534521	IBS 185-430-10	185	430	10,5	12	24	15	31	2	1,07
	534522	IBS 185-530-10	185	530	10,5	12	24	15	31	2	1,26
	534523	IBS 185-630-10	185	630	10,5	12	24	15	31	2	1,48
	534524	IBS 185-830-10	185	830	10,5	12	24	15	31	2	1,9
	534525	IBS 185-1030-10	185	1030	10,5	12	24	15	31	2	2,3

	Part No.	IBS 240	S mm ²	L mm	Ø mm	A mm	J mm	M mm	K mm		Kg
630 A	534526	IBS 240-330-12	240	330	12,5	13	32	15	36	2	1,03
	534527	IBS 240-430-12	240	430	12,5	13	32	15	36	2	1,34
	534528	IBS 240-530-12	240	530	12,5	13	32	15	36	2	1,65
	534529	IBS 240-630-12	240	630	12,5	13	32	15	36	2	1,96
	534530	IBS 240-830-12	240	830	12,5	13	32	15	36	2	2,58
	534531	IBS 240-1030-12	240	1030	12,5	13	32	15	36	2	3,2

Insulated Braided conductor type	Section mm ²	ΔT (K)							Current Coefficient
		30	40	45	50	55	60	70	
IBS 120	120	325	376	398	420	441	460	497	1,6
IBS 185	185	407	470	499	526	552	576	622	1,6
IBS 240	240	488	563	598	630	661	690	745	1,6

ADMISSIBLE CURRENTS: This table indicates the temperature rise produced by chosen current in the given section. This calculation does not take into account the heat dissipation from the switch gear.

IBSHY Insulated Braided Conductor for Compact Circuit Breakers



FEATURES

- Suitable for all main 125/160 A electrical devices and specifically molded case circuit breakers
- Resistant to vibration, improving reliability and performance
- Improves assembly flexibility and aesthetics
- Quick and easy installation
- No additional cutting, stripping, crimping and punching needed
- Small wire diameter provides maximum flexibility
- Halogen-free solution for applications requiring a low smoke solution
- DNV-GL certified busbar systems for electrical installation for ship and marine application
- Conforms to NF EN 45545 obtaining an HL2 classification for chapters R22 and R23
- High working temperature
- RoHS compliant

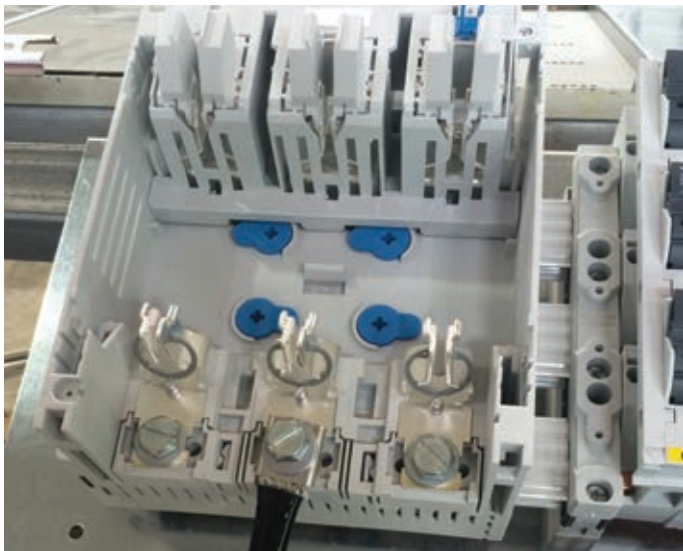

IBSHY INSULATED BAIDED CONDUCTOR SPECIFICATIONS

- Typical Application Current Rating: 160 A
- Finish: Tinned
- Material: Copper; Glass Fibre Reinforced Silicon
- Flammability Rating: UL 1441 VW-1
- Max Working Voltage. IEC (Ui): 1 000 VAC; 1 500 VDC
- Operating Temperature: from -60 to 250°C
- Wire Diameter: 0.15 mm
- IEC 60439-1; IEC 61439-1 compliant

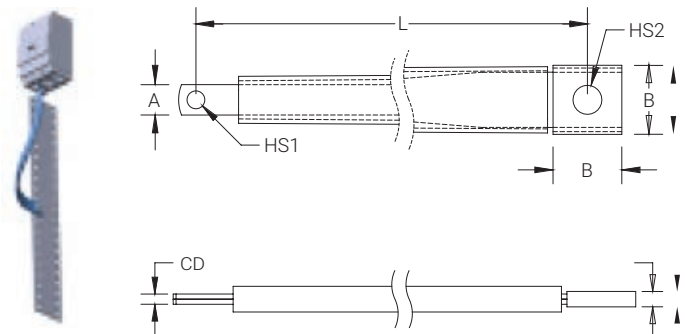

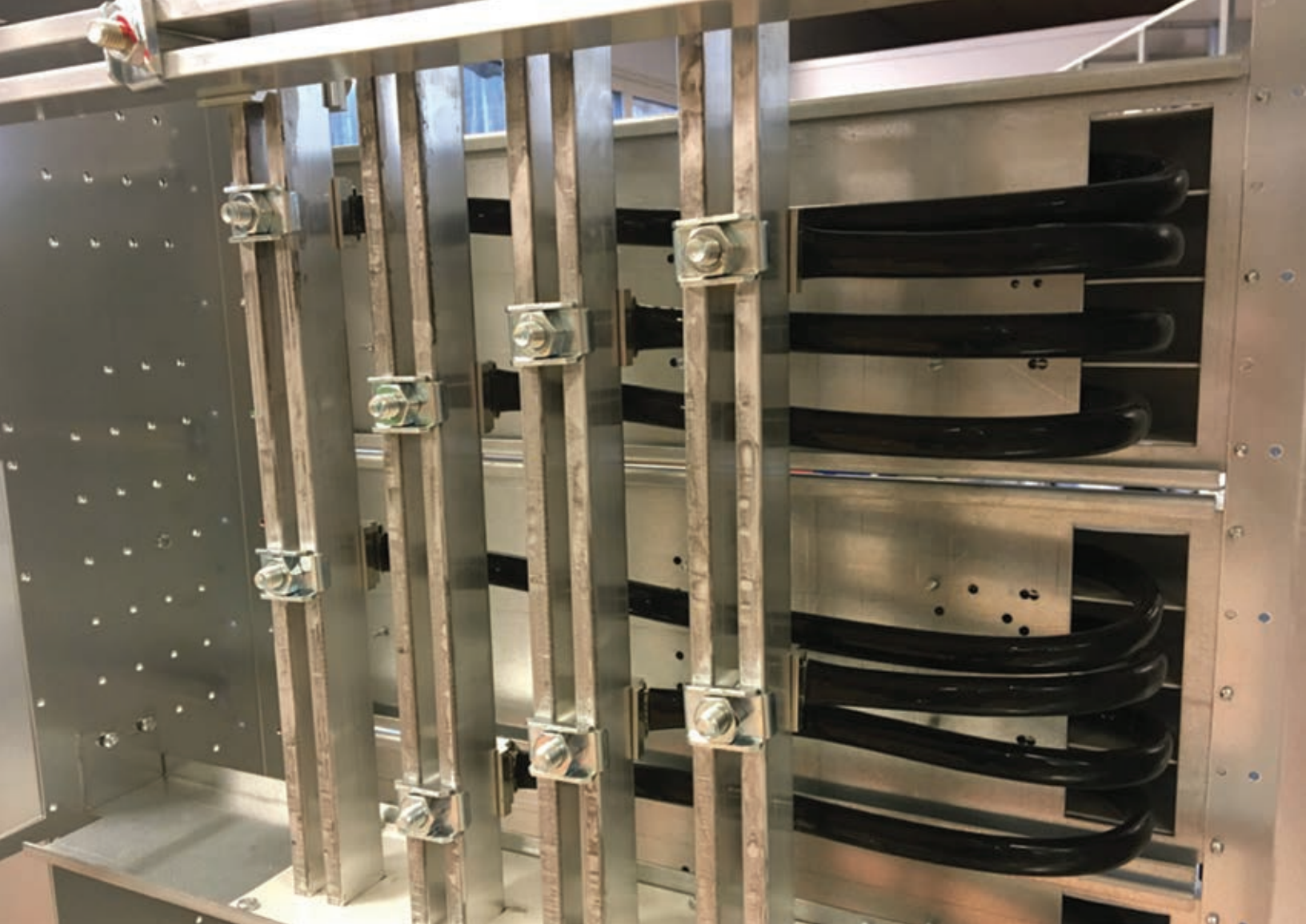

IBSHY INSULATED BAIDED CONDUCTOR TECHNICAL CHARACTERISTICS

Part No.	Article No.	Cross Section	Length L	A	B	C	D	Hole Size 1 HS1	Hole Size 2 HS2
IBSHY32-230	558584	32 mm ²	230 mm	11 mm	25 mm	3 mm	5 mm	6.5 mm	10.5 mm
IBSHY32-330	558586	32 mm ²	330 mm	11 mm	25 mm	3 mm	5 mm	6.5 mm	10.5 mm
IBSHY32-365	558587	32 mm ²	365 mm	11 mm	25 mm	3 mm	5 mm	6.5 mm	10.5 mm
IBSHY32-430	558588	32 mm ²	430 mm	11 mm	25 mm	3 mm	5 mm	6.5 mm	10.5 mm
IBSHY32-500	558589	32 mm ²	500 mm	11 mm	25 mm	3 mm	5 mm	6.5 mm	10.5 mm
IBSHY32-565	558591	32 mm ²	565 mm	11 mm	25 mm	3 mm	5 mm	6.5 mm	10.5 mm
IBSHY32-630	558592	32 mm ²	630 mm	11 mm	25 mm	3 mm	5 mm	6.5 mm	10.5 mm
IBSHY32-700	558593	32 mm ²	700 mm	11 mm	25 mm	3 mm	5 mm	6.5 mm	10.5 mm
IBSHY32-765	558594	32 mm ²	765 mm	11 mm	25 mm	3 mm	5 mm	6.5 mm	10.5 mm
IBSHY32-830	558595	32 mm ²	830 mm	11 mm	25 mm	3 mm	5 mm	6.5 mm	10.5 mm

Maximum Ampacity Ratings															
Cross Section (mm ² /kcmil)	ΔT 30° C (A)	ΔT 35° C (A)	ΔT 40° C (A)	ΔT 45° C (A)	ΔT 50° C (A)	ΔT 55° C (A)	ΔT 60° C (A)	ΔT 65° C (A)	ΔT 70° C (A)	ΔT 75° C (A)	ΔT 80° C (A)	ΔT 100° C (A)	ΔT 120° C (A)	2 Bar Current Coefficient	3 Bar Current Coefficient
32/63.15	142	153	164	174	184	193	201	209	217	225	235	263	290	1.6	2

ΔT = Temperature of conductors – Internal temperature of panel.

This table indicates the temperature rise produced by chosen current in the given section. This calculation does not take into account the heat dissipation from the switch gear.



ASSEMBLY INSTRUCTIONS

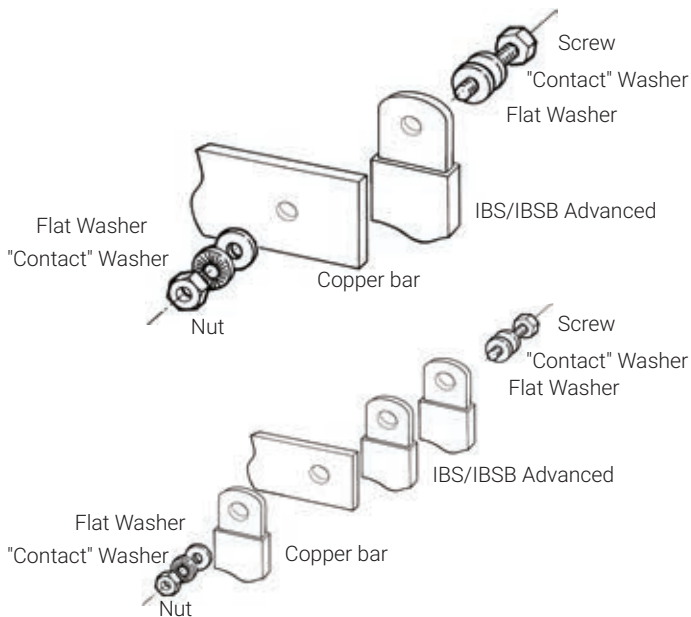

Space between 2 or 3 insulated braided conductors in parallel, for cooling.

A minimum air gap is required. Use FS type spacer clamp.

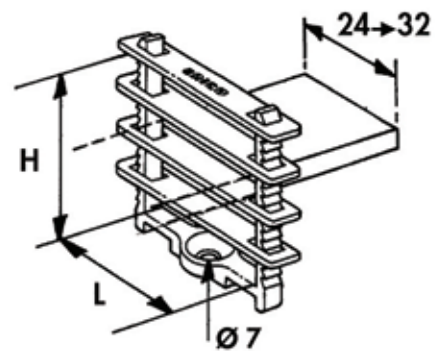

Designation	Part No.	For insulated braided conductor type
FS 24	553550	IBS Advanced 25 / 50 IBSB Advanced 25 / 50 / 70 / 100
FS 32	553560	IBSB Advanced 120 / 185 / 240

Grounding and Bonding Tinned Copper Braids (MBJ & BJ)

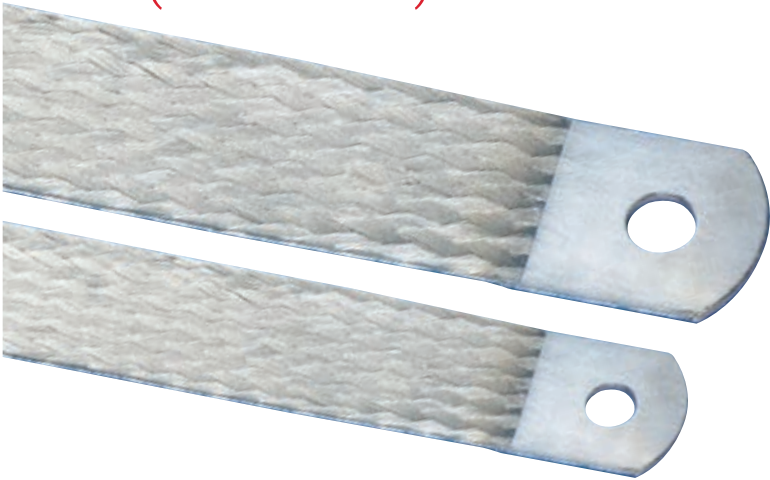

INNOVATIVE, STATE-OF-THE-ART MANUFACTURING PROCESS.

nVent ERIFLEX manufacturing directly the palms of the MBJ tinned-plated braids. This manufacturing process provides an effective electrical contact, due to the integral palms, without the addition of tin or crimped lugs.

This process welds the flexible braid and brings back a solid tinned or red copper block as a palm. Unlike the traditional press-welded palms process. nVent ERIFLEX's process is suitable for red copper, but also for tin plated copper. The electrical contact between each wire is optimized.



This nVent ERIFLEX process also helps eliminate moisture issues in the palms. By using crimped lugs in a severe environment, moisture can enter the lug (often by capillarity) and create corrosion between each wire. After several years, the electrical contact between each wire can deteriorate and alter the electrical conductivity of the equipment. The corrosion in the palm is impossible to remove without changing the element.

This process produces RoHS products; no additional substances are added to the tinned-plated wires during the manufacturing process.

BJ

Round braids with crimped lugs



Part No.	Description	Section mm	L mm	Ø D mm	Intensity A	 Kg	
556900	BJ 6-150 S	6	150	6.5	45	10	0.010
556910	BJ 6-200 S	6	200	6.5	45	10	0.015
556920	BJ 10-300 S	10	300	6.5	75	10	0.033

TINNED COPPER EARTH/GROUND BRAIDS TECHNICAL FEATURES

WITH INTEGRAL PALM

- A complete range of earth/ground flexible connections from 6 to 100 mm² section and from 100 to 500 mm length
- Strong resistance to vibration and fatigue
- Reliable: No extra contact due to the lugs crimped at the ends of the cable
- Weight savings: A flat braid weighs less than a cable (with insulation) and lugs and offers better copper usage (skin effect)
- Integral palm, without tin or crimped lugs for superior electrical contact and tensile strength resistance
- Quick and easy to install: Ready to use, No cutting, stripping, crimping or punching. Less labor time for installation
- Material savings: no lugs or terminals
- Recommended by the EMC/EMI directives and less impedance than cables



EARTH/GROUND COPPER BRAIDS (MBJ & BJ) TECHNICAL CHARACTERISTICS

Part Number	Description	Intensity A	Thickness mm	Section mm ²	L mm	Ø mm	J mm	T mm			Kg
556600	MBJ 6-150-6	40	1.1	6	150	6.5	11	18	10		0.01
563410	MBJ 6-200-6	40	1.1	6	200	6.5	11	18	10		0.0167
556930	MBJ 10-200-6	75	1.1	10	200	6.5	11	18	10		0.022
556610	MBJ 10-300-6	75	1.1	10	300	6.5	11	18	10		0.033
563540	MBJ 16-100-6	120	1.5	16	100	6.5	15	20	10		0.018
556620	MBJ 16-100-8	120	1.5	16	100	8.5	15	20	10		0.018
563550	MBJ 16-150-6	120	1.5	16	150	6.5	15	20	10		0.035
556630	MBJ 16-150-8	120	1.5	16	150	8.5	15	20	10		0.035
563300	MBJ 16-200-6	120	1.5	16	200	6.5	15	20	10		0.033
556640	MBJ 16-200-8	120	1.5	16	200	8.5	15	20	10		0.033
556650	MBJ 16-250-8	120	1.5	16	250	8.5	15	20	10		0.04
563320	MBJ 16-300-6	120	1.5	16	300	6.5	15	20	10		0.05
556660	MBJ 16-300-8	120	1.5	16	300	8.5	15	20	10		0.05
556940	MBJ 16-500-8	120	1.5	16	500	8.5	15	20	10		0.082
556670	MBJ 25-100-10	150	1.5	25	100	10.5	22	28	10		0.027
556680	MBJ 25-150-10	150	1.5	25	150	10.5	22	28	10		0.039
563340	MBJ 25-200-6	150	1.5	25	200	6.5	22	28	10		0.052
556690	MBJ 25-200-10	150	1.5	25	200	10.5	22	28	10		0.052
563430	MBJ 25-200-12	150	1.5	25	200	12.5	22	28	10		0.052
556700	MBJ 25-250-10	150	1.5	25	250	10.5	22	28	10		0.064
556710	MBJ 25-300-10	150	1.5	25	300	10.5	22	28	10		0.077
556950	MBJ 25-500-10	150	1.5	25	500	10.5	22	28	10		0.13
556720	MBJ 30-100-10	180	2	30	100	10.5	22	28	10		0.032
556730	MBJ 30-150-10	180	2	30	150	10.5	22	28	10		0.047
556740	MBJ 30-200-10	180	2	30	200	10.5	22	28	10		0.062
556750	MBJ 30-250-10	180	2	30	250	10.5	22	28	10		0.075
556760	MBJ 30-300-10	180	2	30	300	10.5	22	28	10		0.092
556960	MBJ 30-500-10	180	2	30	500	10.5	22	28	10		0.155
556770	MBJ 35-100-10	197	2.1	35	100	10.5	22	28	10		0.037
556780	MBJ 35-150-10	197	2.1	35	150	10.5	22	28	10		0.054
556790	MBJ 35-200-10	197	2.1	35	200	10.5	22	28	10		0.072
556800	MBJ 35-250-10	197	2.1	35	250	10.5	22	28	10		0.089
565000	MBJ 35-250-25	197	3	35	250	25.5	40	45	10		0.089
556810	MBJ 35-300-10	197	2.1	35	300	10.5	22	28	10		0.11
556970	MBJ 35-500-10	197	2.1	35	500	10.5	22	28	10		0.18
556820	MBJ 50-100-10	250	2.5	50	100	10.5	28	33	10		0.052
556830	MBJ 50-150-10	250	2.5	50	150	10.5	28	33	10		0.077
563350	MBJ 50-200-6	250	2.5	50	200	6.5	28	33	10		0.12
556840	MBJ 50-200-10	250	2.5	50	200	10.5	28	33	10		0.12
563440	MBJ 50-200-12	250	2.5	50	200	12.5	28	33	10		0.12
563360	MBJ 50-200-16	250	2.5	50	200	16.5	28	33	10		0.11
563370	MBJ 50-200-18	250	2.5	50	200	18.5	28	33	10		0.11
556850	MBJ 50-250-10	250	2.5	50	250	10.5	28	33	10		0.127
563380	MBJ 50-300-6	250	2.5	50	300	6.5	28	33	10		0.15
556860	MBJ 50-300-10	250	2.5	50	300	10.5	28	33	10		0.153
563390	MBJ 50-300-16	250	2.5	50	300	16.5	28	33	10		0.15
563400	MBJ 50-300-18	250	2.5	50	300	18.5	28	33	10		0.14
556980	MBJ 50-500-10	250	2.5	50	500	10.5	28	33	10		0.255
563560	MBJ 50-500-12	250	2.5	50	500	12.5	28	33	10		0.255
563450	MBJ 70-300-6	290	3.4	70	300	6.5	28	33	10		0.21
563460	MBJ 70-300-10	290	3.4	70	300	10.5	28	33	10		0.21
563420	MBJ 70-300-12	290	3.4	70	300	12.5	28	33	10		0.21
563470	MBJ 70-300-16	290	3.4	70	300	16.5	28	33	10		0.2
563480	MBJ 70-300-22	290	3	70	300	22.5	40	45	10		0.2
563490	MBJ 70-500-10	290	3.4	70	500	10.5	28	33	10		0.34
563500	MBJ 100-250-16	349	4	100	250	16.5	50	55	10		0.254
563510	MBJ 100-250-30	349	4	100	250	30.5	50	55	10		0.254
563520	MBJ 100-500-16	349	4	100	500	16.5	50	55	10		0.508
563530	MBJ 100-500-30	349	4	100	500	30.5	50	55	10		0.508

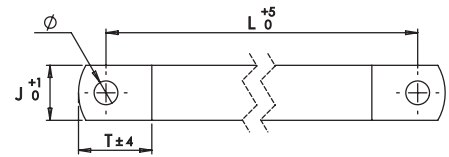
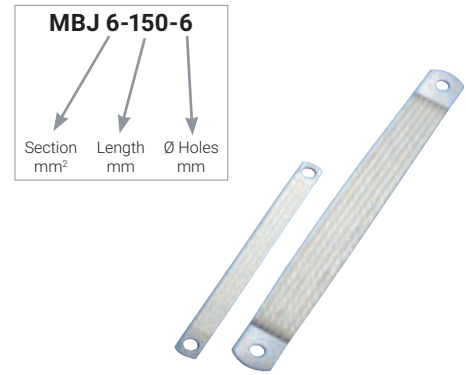

TECHNICAL DATA

- Recommended by EMC/EMI directives
- Flat tinned copper braids
- Electrolytic copper Cu-ETP according to standard EN13602
- Copper purity of minimum 99.9%
- Maximum resistivity of 0.017241 mm²/m at 20°C
- Standard wire diameter; 0.15 mm
- Bends very close to the contact area

CERTIFICATION & APPROVALS

- UL Listed (UL467) except BJ
- EAC certificate
- RoHS 2002/95/EC Compliant
- IEC 60439-1 & 61439-1

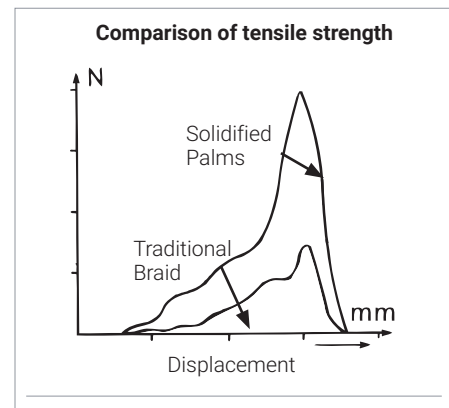

Grounding and Bonding Braid, Tinned Copper with Halogen Free & Flame retardant Yellow Green insulation

MBJ YG

MBJYG Grounding and Bonding Braids are a reliable and convenient ground solution for applications that require flexibility and durability. Designed with halogen-free and flame retardant Yellow Green insulation, MBJYG braids are made with tinned copper ground braids and solid palms that are ready to install without any additional cutting, stripping, crimping or punching. MBJYG braids also do not require the addition of tin or crimped lugs and the proprietary manufacturing process helps optimize the electrical contact between each wire and helps eliminate moisture issues in the palms, helping prevent corrosion and extend the useful life of the braid.

TECHNICAL DATA

- Provides weight and material savings with lower impedance when compared to similar lugged cables with insulation (Recommended by the EMC/EMI directives)

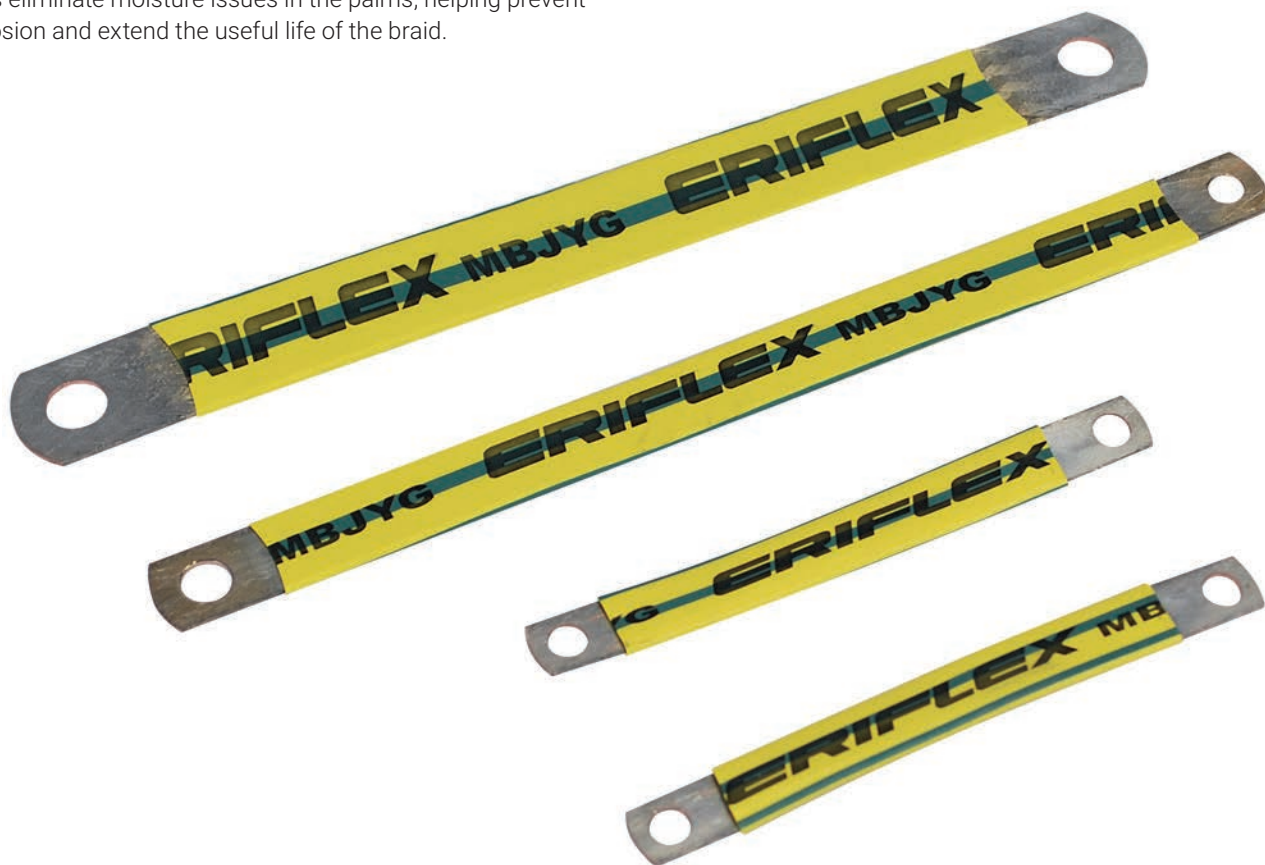

TECHNICAL FEATURE

- Tinned copper, Integral palm, without crimped lugs for superior electrical contact and tensile strength resistance
- Complete range of earth/ground flexible connections from 6 - 25 mm² (11.84 - 49.33 kcmil) cross section and from 100 - 300 mm (3.937" - 11.811") length
- Working Temperature: -55 to 125°C
- Ready to use out of the box, eliminating the need for cutting, stripping, crimping and punching
- Resistant to vibration and fatigue, reducing maintenance

CERTIFICATION & APPROVALS

- Halogen-free and Flame retardant yellow green insulation
- UL 467 listed and IEC 61439-1 certified

Part Number	Article Number	Current A	Thickness T mm	Cross Section mm ²	Length L mm	Hole Size HS mm	A mm	B mm	Unit Weight Kg	Packing unit
MBJYG6-100-6	563601	40	1,1	6	100	6,5	11	18	0,012	10 pc
MBJYG6-150-6	563602				150				0,017	
MBJYG6-200-6	563603				200				0,013	
MBJYG6-250-6	563604				250				0,028	
MBJYG6-300-6	563605				300				0,02	
MBJYG10-100-6	563606	75	1,1	10	100	6,5	11	18	0,012	10 pc
MBJYG10-150-6	563607				150				0,017	
MBJYG10-200-6	563608				200				0,013	
MBJYG10-250-6	563609				250				0,028	
MBJYG10-300-6	563611				300				0,02	
MBJYG16-100-8	563612	120	1,5	16	100	8,5	15	20	0,02	10 pc
MBJYG16-150-8	563613				150				0,028	
MBJYG16-200-8	563614				200				0,036	
MBJYG16-250-8	563615				250				0,044	
MBJYG16-300-8	563616				300				0,052	
MBJYG25-100-8	563617	150	1,5	25	100	8,5	22	28	0,03	10 pc
MBJYG25-150-8	563618				150				0,044	
MBJYG25-200-8	563619				200				0,056	
MBJYG25-250-8	563621				250				0,069	
MBJYG25-300-8	563622				300				0,082	

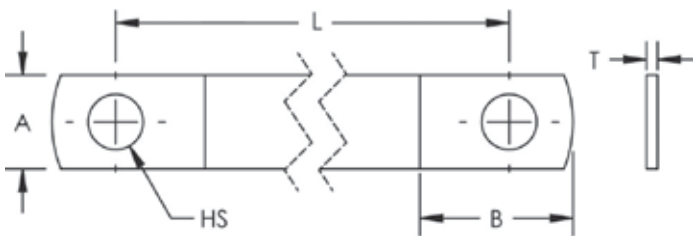

TECHNICAL DATA

- Material: Copper; Polyolefin
- Finish: Tinned
- Dielectric Strength: 15 kV/mm
- Flammability Rating: UL® 224 VW-1
- Halogen-Free Rating: EN 14582
- Nominal Voltage, UL/CSA/IEC: 600 V
- Working Temperature: -55 to 125°C
- Complies With: IEC® 61439.1
- Certifications: CE; cULus; RoHS



Grounding & Bonding Braid Stainless Steel Braids (CPI)



READY-TO-USE STAINLESS STEEL BRAIDS FOR MULTIPLE APPLICATIONS

nVent ERIFLEX develops and manufactures a range of earth/ground stainless steel braids. These high-quality 316L stainless steel braids can be installed in extremely corrosive environments, like offshore applications or coastal applications. The CPI braid is ideal for applications using stainless steel pipe or tanks, like the food and beverage industry, building industry, transportation, oil and chemical industry.

nVent ERIFLEX offers 316L stainless steel, one of the highest resistant stainless steel options on the market. nVent ERIFLEX has mastered the process of manufacturing stainless steel for braiding, crimping, cutting or punching and offers a full range of ready-to-use stainless steel braids.

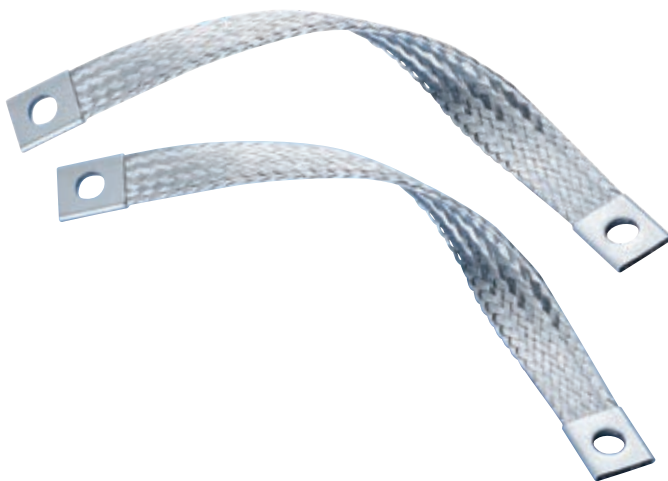

FEATURES

- 316L stainless steel braid ready to use
- Full application range: 16 to 70 mm² section with 150 to 1100 mm length
- High-quality 316L stainless steel: superior abrasion, corrosion, chemical, and UV resistance for outdoor applications
- Good resistance to vibration and fatigue
- Time savings: quick and easy to install. Ready to use. No additional cutting, stripping, crimping and punching needed. Less labor time for installation
- Material savings: No additional lugs or terminals needed
- Durable in outdoor, salt and corrosive environments
- Non-magnetic material
- Long maintenance cycle
- Superior abrasion, corrosion, chemical and UV resistance make it ideal for outdoor applications
- Great for expansion joints where constant movement requires a flexible and indestructible covering
- Won't rust or discolor, so the appearance will never fade or change
- No additional cutting, stripping, or crimping needed
- More flexible connection
- Pre-punched: ready to use
- Excellent electrical contact
- Strong resistance to vibration and fatigue
- Recommended by the EMC directives
- Reduced maintenance

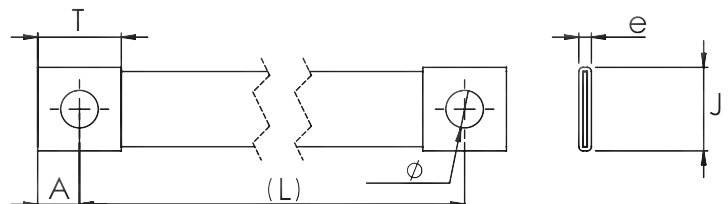

GROUNDING AND BONDING STAINLESS STEEL BRAIDS CPI TECHNICAL CHARACTERISTICS

WHERE STAINLESS BRAIDS CAN BE USED:

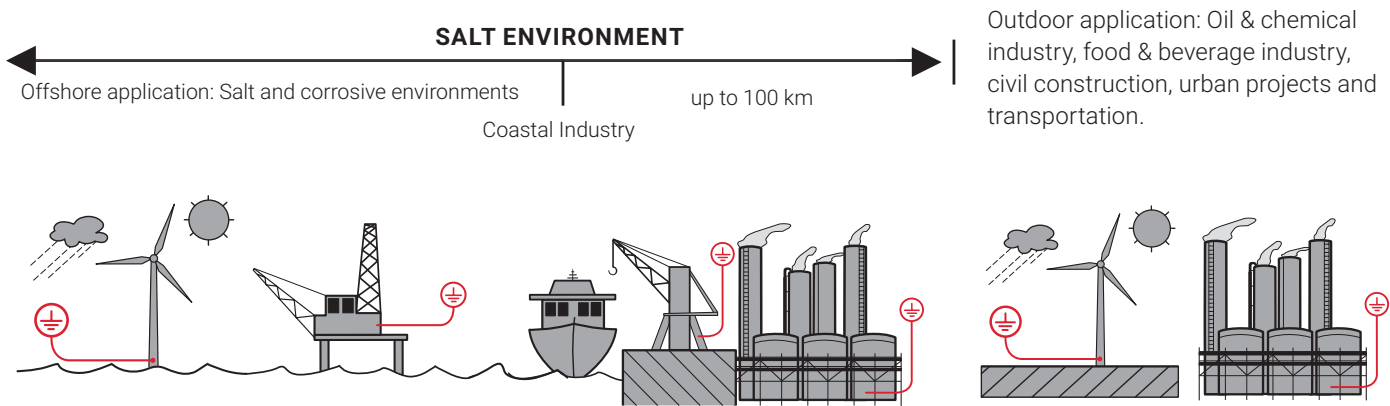

TECHNICAL DATA

- Excellent electrical contact
- Good tensile strength

BRAID

- 316L Stainless steel
- Wire diameter: 0.25 mm for maximum flexibility
- Strong resistance to vibration

CERTIFICATIONS & APPROVALS

- UL Listed UL467 - grounding and bonding equipment for US and Canada
- RoHS Compliant
- IEC 60439-1 & 61439-1
- ABS American Bureau of Shipping Certificate No. 13-HS1018106-1-PDA-DUP

Part Number	Description	Section mm ²	L mm	Ø mm	J mm	A mm	T mm	e mm		Kg
554277	CPI 16-150-8	16	150	8.5	17.5	10	20	3	10	0.031
554278	CPI 16-200-8	16	200	8.5	17.5	10	20	3	10	0.037
554279	CPI 16-250-8	16	250	8.5	17.5	10	20	3	10	0.043
554280	CPI 16-300-8	16	300	8.5	17.5	10	20	3	10	0.050
554282	CPI 16-400-8	16	400	8.5	17.5	10	20	3	10	0.062
554286	CPI 16-600-8	16	600	8.5	17.5	10	20	3	10	0.087
554299	CPI 25-150-10	25	150	10.5	26.5	15	30	3.5	10	0.058
554300	CPI 25-200-10	25	200	10.5	26.5	15	30	3.5	10	0.068
554301	CPI 25-250-10	25	250	10.5	26.5	15	30	3.5	10	0.078
554302	CPI 25-300-10	25	300	10.5	26.5	15	30	3.5	10	0.088
554304	CPI 25-400-10	25	400	10.5	26.5	15	30	3.5	10	0.108
554308	CPI 25-600-10	25	600	10.5	26.5	15	30	3.5	10	0.147
554321	CPI 35-150-12	35	150	13	26.5	15	30	4	10	0.071
554322	CPI 35-200-12	35	200	13	26.5	15	30	4	10	0.085
554323	CPI 35-250-12	35	250	13	26.5	15	30	4	10	0.099
554324	CPI 35-300-12	35	300	13	26.5	15	30	4	10	0.112
554326	CPI 35-400-12	35	400	13	26.5	15	30	4	10	0.140
554330	CPI 35-600-12	35	600	13	26.5	15	30	4	10	0.195
554343	CPI 50-150-12	50	150	13	30	15	30	5	10	0.111
554344	CPI 50-200-12	50	200	13	30	15	30	5	10	0.130
554345	CPI 50-250-12	50	250	13	30	15	30	5	10	0.150
554346	CPI 50-300-12	50	300	13	30	15	30	5	10	0.170
554348	CPI 50-400-12	50	400	13	30	15	30	5	10	0.209
554352	CPI 50-600-12	50	600	13	30	15	30	5	10	0.288
554365	CPI 70-150-12	70	150	13	30	15	30	5.8	10	0.139
554366	CPI 70-200-12	70	200	13	30	15	30	5.8	10	0.167
554367	CPI 70-250-12	70	250	13	30	15	30	5.8	10	0.194
554368	CPI 70-300-12	70	300	13	30	15	30	5.8	10	0.222
554370	CPI 70-400-12	70	400	13	30	15	30	5.8	10	0.277
554374	CPI 70-600-12	70	600	13	30	15	30	5.8	10	0.388
554378	CPI 70-800-12	70	800	13	30	15	30	5.8	10	0.498
554384	CPI 70-1100-12	70	1100	13	30	15	30	5.8	10	0.664

Grounding & Bonding Braid Stainless Steel Braids (CPIW)



High-quality CPIW stainless steel grounding and bonding braids can be installed in corrosive environments like offshore applications or coastal applications. The full range of CPIW braids are ideal for applications using stainless steel pipe or tanks, like the food and beverage industry, building industry, transportation or oil and chemical industry.

nVent ERIFLEX offers 316L stainless steel braids, one of the highest resistant stainless steel options on the market. Our proprietary manufacturing process has been optimized to provide the best braiding, welding and connection palm.

FEATURES

- Superior abrasion, corrosion, chemical and UV resistance make CPIW braids ideal for outdoor applications
- Covering from M20 (3/4"-10) up to M42 (1 1/2"-6) bolt fixation point
- Great for expansion joints where constant movement requires a flexible and durable solution
- Ready to use out of the box, eliminates the need for cutting, stripping, crimping and punching
- Quick and easy to install
- Resistant to vibration and fatigue. reducing maintenance
- Will not rust or discolor, so the appearance will never fade or change
- Excellent electrical contact
- No additional lugs or terminals needed
- Non-magnetic material
- Recommended by the EMC/EMI directives
- Performs to the class C5 (very high) category as per ISO 12944-2
- EAC compliant
- RoHS compliant

CPIW GROUNDING AND BONDING BRAID SPECIFICATIONS

- Material: Stainless Steel 316L (EN 1.4404)
- Certification details: UL 467
- Complies with: IEC 60439-1; IEC 61439-1

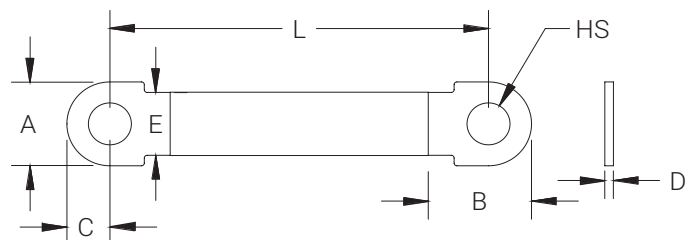

CPIW GROUNDING AND BONDING BRAID, TECHNICAL CHARACTERISTICS



Part No.	Article No.	Cross Section mm ²	L mm	HS mm	A mm	B mm	C mm	D mm	E mm	Unit Weight Kg	Minimum Order Quantity
CPIW50-200-20B	554386B	50	200	21	42	51	21	3	30	0.128	50
CPIW50-200-24B	554401B	50	200	25	52	62	26	3	30	0.154	50
CPIW50-250-20B	554398B	50	250	21	42	51	21	3	30	0.148	50
CPIW50-250-24B	554403B	50	250	25	52	62	26	3	30	0.176	50
CPIW50-250-27B	554405B	50	250	28	58	69	29	3	30	0.195	50
CPIW50-250-30B	554407B	50	250	31	62	74	31	3	30	0.207	50
CPIW50-300-20B	554427B	50	300	21	42	51	21	3	30	0.200	50
CPIW50-300-24B	554428B	50	300	25	52	62	26	3	30	0.210	50
CPIW50-300-27B	554429B	50	300	28	58	69	29	3	30	0.220	50
CPIW50-300-30B	554409B	50	300	31	62	74	31	3	30	0.229	50
CPIW50-300-33B	554412B	50	300	34	68	78	34	3	30	0.246	50
CPIW50-300-39B	554416B	50	300	40	78	89	39	3	30	0.284	50
CPIW50-300-42B	554421B	50	300	43	82	94	41	3	30	0.301	50
CPIW50-400-33B	554414B	50	400	34	68	78	34	3	30	0.288	50
CPIW50-400-39B	554418B	50	400	40	78	89	39	3	30	0.327	50
CPIW50-400-42B	554423B	50	400	43	82	94	41	3	30	0.344	50
CPIW70-200-20B	554397B	70	200	21	42	51	21	3	30	0.149	50
CPIW70-200-24B	554402B	70	200	25	52	62	26	3	30	0.175	50
CPIW70-250-20B	554399B	70	250	21	42	51	21	3	30	0.178	50
CPIW70-250-24B	554404B	70	250	25	52	62	26	3	30	0.203	50
CPIW70-250-27B	554406B	70	250	28	58	69	29	3	30	0.221	50
CPIW70-250-30B	554408B	70	250	31	62	74	31	3	30	0.233	50
CPIW70-300-30B	554411B	70	300	31	62	74	31	3	30	0.262	50
CPIW70-300-33B	554413B	70	300	34	68	78	34	3	30	0.278	50
CPIW70-300-39B	554417B	70	300	40	78	89	39	3	30	0.315	50
CPIW70-300-42B	554422B	70	300	43	82	94	41	3	30	0.331	50
CPIW70-400-20B	554388B	70	400	21	42	51	21	3	30	0.264	50
CPIW70-400-33B	554415B	70	400	34	68	78	34	3	30	0.336	50
CPIW70-400-39B	554419B	70	400	40	78	89	39	3	30	0.373	50
CPIW70-400-42B	554424B	70	400	43	82	94	41	3	30	0.389	50

Power Shunt (PBC)

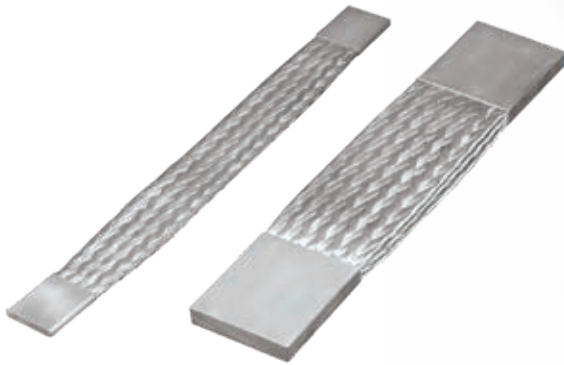

- High flexibility
- Reduce vibrations
- Ideal for transformer-busduct link
- Intensity: Up to 4600 A

PBC BRAIDED POWER SHUNTS

- Undrilled palms to customer's specific designs, fitted by power press
- Extra-flexible power connections (expansion rings, busbar...)
- Tinned electrolytic copper strand 0.15 mm
- When used in parallel, the 2 shunts must be spaced with a minimum distance equal to the thickness of the shunt to allow air cooling

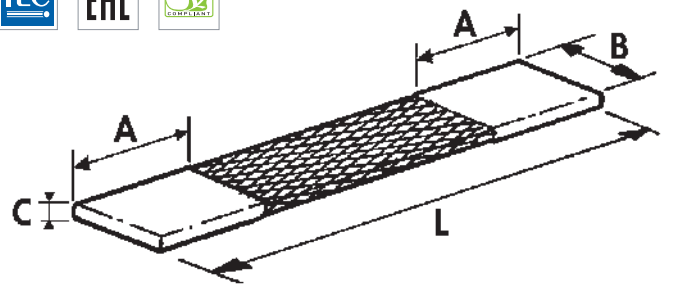

Part No.	Description	Section mm ²	Intensity (ΔT 30K)		Intensity (ΔT 50K)		A mm	B mm	C mm	L mm	Box	Kg
			↙	↘	↙	↘						
564000	PBC 100 x 250	100	349	600	462	795	35	40	7.0	250	2	0.38
564050	PBC 100 x 500	100	349	600	462	795	35	40	7.0	500	2	0.63
564010	PBC 120 x 250	120	385	670	511	877	35	40	7.5	250	2	0.42
564100	PBC 150 x 250	150	440	757	583	1003	55	50	8.0	250	2	0.63
564150	PBC 150 x 500	150	440	757	583	1003	55	50	8.0	500	2	0.90
564200	PBC 200 x 250	200	550	946	729	1253	55	50	9.0	250	2	0.76
564250	PBC 200 x 500	200	550	946	729	1253	55	50	9.0	500	2	1.20
564300	PBC 250 x 300	250	651	1120	863	1484	85	50	10.5	300	2	1.03
564400	PBC 300 x 400	300	716	1180	948	1565	85	60	11.0	400	1	1.53
564500	PBC 400 x 400	400	853	1360	1131	1808	85	80	11.0	400	1	2.20
564600	PBC 500 x 400	500	917	1561	1216	1944	105	100	11.0	400	1	2.64
564700	PBC 600 x 450	600	1101	1762	1459	2334	105	100	13.0	450	1	3.40
564800	PBC 800 x 450	800	1376	2202	1823	2917	105	100	14.0	450	1	4.26
564900	PBC 1000 x 450	1000	1651	2642	2188	3500	105	100	16.0	450	1	5.47
564030	PBC 1200 x 500	1200	1982	3170	2626	4208	125	120	17.5	500	1	7.16

Power Shunt (PPS)

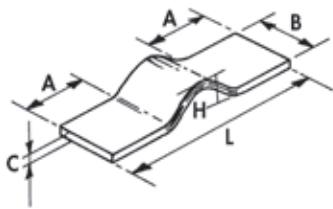
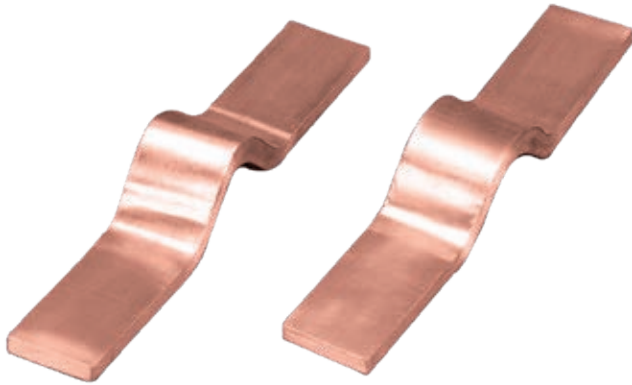

FEATURES

Press welding is welding of laminations to each other through direct current applied to pieces under pressure.

This technique results in:

- The formation of a solid palm with properties of plain bar
- Smaller cross section for same capacity
- Runs cooler than equal section
- Plain copper, thickness of laminates 0.2 mm
- When used in parallel, the 2 shunts must be spaced with a minimum distance equal to the thickness of the shunt

Part No.	Description	Section mm ²	Intensity (ΔT 30K)		Intensity (ΔT 50K)		A mm	B mm	C mm	L mm	H mm	Kg	
566030	PPS 50/10/80-280	500	1022	1758	1354	2329	80	50	10	280	58	1	1.440
566040	PPS 80/10/100-320	800	1511	2493	2002	3303	100	80	10	320	52	1	2.625
566050	PPS 100/10/100-300	1000	1825	2920	2418	3869	100	100	10	300	54	1	3.065
566060	PPS 100/10/110-360	1000	1825	2920	2418	3869	110	100	10	360	53	1	3.610
566070	PPS 100/15/110-360	1500	2178	3485	2886	4617	110	100	15	360	57	1	5.385

CUSTOM SOLUTIONS

nVent ERIFLEX can provide made-to-order, custom configurations to your drawing specifications.

nVent ERIFLEX copper braids can be made to custom lengths, widths, thicknesses and hole patterns; with PVC installation, in flat or tubular shapes, using copper wire, in continuous coils, or with soldered studs or crimped lugs. Let nVent ERIFLEX solve your design and production scheduling challenges.



Flat Copper & Stainless Steel Braids (FTCB, FRCB, FSSB & FTCBI)

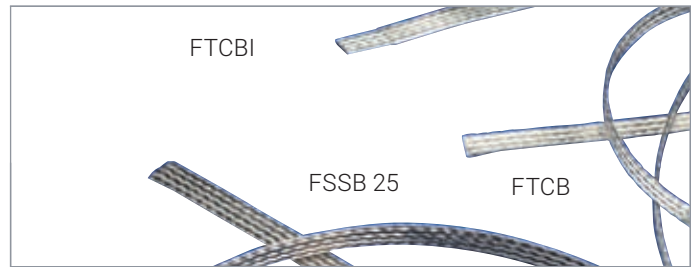
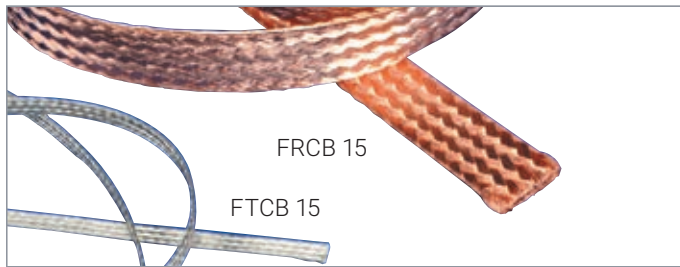

FTCB 15 FLAT TINNED COPPER BRAIDS



- Standard wire diameter: 0.15 mm
- 25 m coils

Part No.	Description	Section mm ²	mm	Number of Wire	Nominal Current A			Kg
557200	FTCB 15-3	3	5x1	168	30	25 m		0.03
557210	FTCB 15-5	5	8x1	288	45	25 m		0.05
557220	FTCB 15-8	8	8x1.5	456	65	25 m		0.08
557230	FTCB 15-10	10	10x1.5	576	75	25 m		0.10
557240	FTCB 15-16	16	15x1.5	896	120	25 m		0.16
557250	FTCB 15-20	20	20x1.5	1120	140	25 m		0.20
557260	FTCB 15-25	25	23x1.5	1404	150	25 m		0.25
557270	FTCB 15-30	30	23x2.0	1692	180	25 m		0.30
557280	FTCB 15-35	35	23x2.5	1980	200	25 m		0.35
557290	FTCB 15-40	40	25x2.5	2272	220	25 m		0.40
557300	FTCB 15-50	50	28x3	2848	250	25 m		0.50
557310	FTCB 15-60	60	30x3	3392	280	25 m		0.60
557320	FTCB 15-70	70	30x3.5	3968	290	25 m		0.70
557330	FTCB 15-75	75	30x4	4256	300	25 m		0.75
557350	FTCB 15-100	100	40x4	5664	360	25 m		1.00

FRCB 15 FLAT PLAIN COPPER BRAIDS

- Standard wire diameter: 0.15 mm
- 25 m coils

Part No.	Description	Section mm ²	mm	Number of Wire	Nominal Current A			Kg
557030	FRCB 15-10	10	10x1.5	576	75	25 m		0.10
557040	FRCB 15-16	16	15x1.5	896	120	25 m		0.16
557050	FRCB 15-20	20	20x1.5	1120	140	25 m		0.20
557060	FRCB 15-25	25	23x1.5	1404	150	25 m		0.25
557080	FRCB 15-35	35	23x2.5	1980	200	25 m		0.35
557090	FRCB 15-40	40	25x2.5	2272	220	25 m		0.40
557100	FRCB 15-50	50	28x3	2848	250	25 m		0.50
557120	FRCB 15-70	70	30x3.5	3968	290	25 m		0.70
557130	FRCB 15-75	75	30x4	4256	300	25 m		0.75
557150	FRCB 15-100	100	40x4	5664	360	25 m		1.00

FTCBI INSULATED FLAT TINNED COPPER BRAIDS

- Insulation in clear PVC, thickness 1 mm, self-extinguishing UL 94 VO
- Standard wire diameter: 0.15 mm
- 25 m coils
- Insulation voltage: 450 V
- Working temperature: up to 70°C

Part No.	Description	Section mm ²	mm	Number of Wire	Nominal Current A			Kg
510300	FTCBI 16	16	17x3.5	896	120	25 m		0.18
510310	FTCBI 25	25	25x3.5	1404	150	25 m		0.29
510340	FTCBI 50	50	30x5	2848	250	25 m		0.60

FTCB 20 FLAT TINNED COPPER BRAIDS



- Standard wire diameter: 0.20 mm
- Extra long reels

Part No.	Description	Section mm ²	mm	Number of Wire	Nominal Current A			Kg
503510	FTCB 20-5	5	8x1	168	45	500 m		0.05
503520	FTCB 20-10	10	10x1.5	312	75	150 m		0.10
503530	FTCB 20-16	16	15x2	512	120	150 m		0.16
503540	FTCB 20-25	25	25x1.5	792	150	100 m		0.25

FSSB 25 STAINLESS STEEL FLAT BRAIDS



- Standard wire diameter: 0.25 mm
- Stainless steel 316L

Part No.	Description	Section mm ²	mm			Kg
557160	FSSB 25-16 ²	16	15x1.5	25 m		0.14
557170	FSSB 25-25 ²	25	23x1.5	25 m		0.22
557390	FSSB 25-50 ²	50	30x3	25 m		0.44

Round & Tubular Copper Braids (RTCB, RRCT, TTCE, RRCBI & RTCB)

- A large range of braids
- Bare or insulated

- Tubulars for shielding
- Stainless steel for corrosive environment

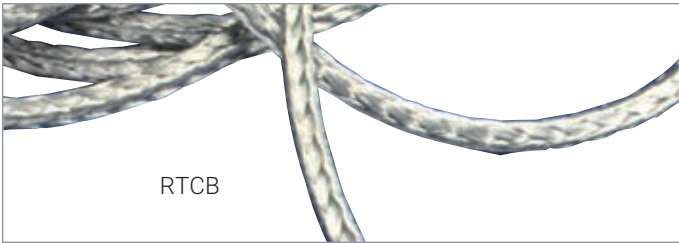

RTCB

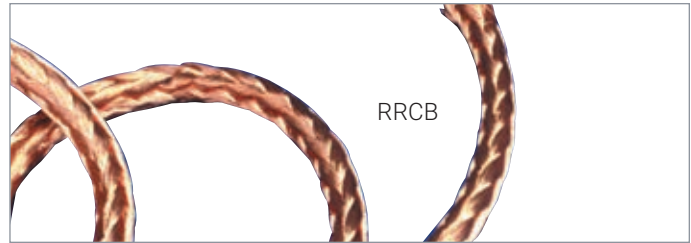

RRCB

RTCB/RTCB HL TINNED COPPER ROUND BRAIDS



RRCB PLAIN COPPER ROUND BRAIDS

Part No.	Description	Section mm ²	External dia in mm	Number of Wire	Nominal Current A		
557600	RTCB 15-6	6	4	352	45	25 m	0.06
557610	RTCB 15-8	8	4.5	464	65	25 m	0.08
557620	RTCB 15-10	10	5	560	75	25 m	0.10
557630	RTCB 15-16	16	6	900	120	25 m	0.16
557640	RTCB 15-25	25	8	1416	150	25 m	0.25
557650	RTCB 15-30	30	9	1680	180	25 m	0.30
557660	RTCB 15-50	50	11	2820	250	25 m	0.50
557670	RTCB 15-75	75	13.5	4236	300	25 m	0.75
557680	RTCB 15-100	100	17	5652	360	25 m	1.00

Standard wire diameter 0.15 mm - Extra long reels

503700	RTCB 15-10/HL	10	5	560	75	100 m	0.100
503710	RTCB 15-16/HL	16	6	900	120	100 m	0.160
503720	RTCB 15-25/HL	25	7.5	1416	150	100 m	0.250

- Standard wire diameter: 0.15 mm
- 25 m coils

Part No.	Description	Section mm ²	External dia in mm	Number of Wire	Nominal Current A		
557400	RRCB 15-6	6	4	352	45	25 m	0.06
557420	RRCB 15-10	10	5	560	75	25 m	0.10
557430	RRCB 15-16	16	6	900	120	25 m	0.16
557440	RRCB 15-25	25	8	1416	150	25 m	0.25
557450	RRCB 15-30	30	9	1680	180	25 m	0.30
557460	RRCB 15-50	50	11	2820	250	25 m	0.50
557470	RRCB 15-75	75	14	4236	300	25 m	0.75

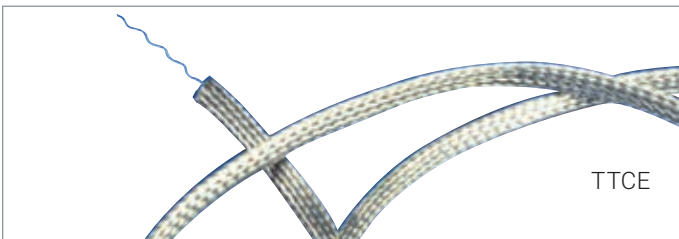

TTCE

TTCE TINNED COPPER TUBULAR BRAIDS

- For screening connecting cables between equipment used in an electromagnetically disturbed environment.
- Supplied with draw wire

Part No.	Description	Section mm ²	Diameter (mm)				Number of Wire	Ø wires mm	Nominal Current A		
			Int.	Covering %	Exp.	Covering %					
510100	TTCE 3	1.7	3	100%	6	90%	96	0.15	13	50 m	0.020
510110	TTCE 5	2.5	5	99%	10	92%	144	0.15	19	50 m	0.026
510120	TTCE 8	4.45	8	99%	16	95%	252	0.15	37	50 m	0.050
510130	TTCE 10	5.7	10	100%	20	92%	320	0.15	43	50 m	0.054
510140	TTCE 15	12	15	100%	25	94%	334	0.15	90	50 m	0.120
510150	TTCE 20	20.4	20	99%	40	87%	288	0.30	122	50 m	0.190
510160	TTCE 25	27.1	25	99%	50	92%	384	0.30	163	25 m	0.270
510170	TTCE 30	33.9	30	100%	60	90%	480	0.30	185	25 m	0.320
510180	TTCE 35	40.7	35	100%	70	94%	576	0.30	244	25 m	0.380

Extra long reels

504690	TTCE 8/HL	6.8	8	-	16	-	216	0.15	37	200 m	0.050
--------	-----------	-----	---	---	----	---	-----	------	----	-------	-------

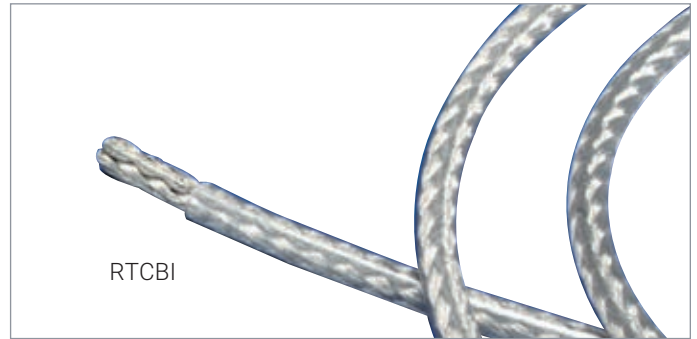
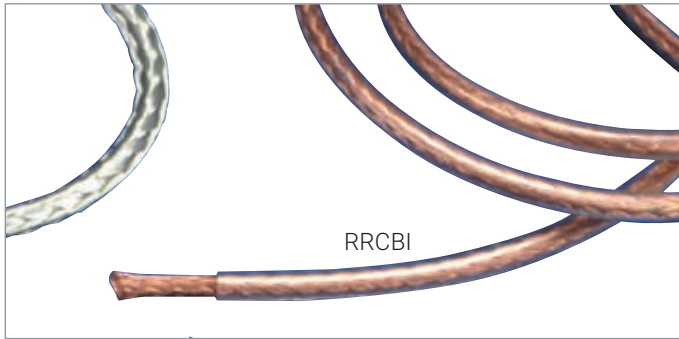

The primary use of tubular braid is to provide sensitive cables with an EMC/EMI screen to shield them against electromagnetic, electrostatic and radio frequency interference. Optimum screening performance is obtained using copper wire braid that can also be used for earth continuity purposes.

Round & Tubular Copper Braids (RTCB, RRCT, TTCE, RRCBI & RTCBI)





RRCBI INSULATED PLAIN COPPER ROUND BRAIDS

- Insulation in clear PVC, thickness 1 mm, self-extinguishing UL 94 - VO
- Standard wire diameter: 0.15 mm
- Insulation voltage: 450 V
- Working temperature: up to 70°C

Part No.	Description	Section mm ²	External dia in mm	Number of Wire	Nominal Current A		 Kg
510500	RRCBI 15-10	10	7	560	75	25 m	0.10
510510	RRCBI 15-16	16	8	900	120	25 m	0.16

RTCBI / RTCBI HL INSULATED ROUND TINNED COPPER BRAIDS

- Insulation in clear PVC, thickness 1 mm, self-extinguishing UL 94 - VO
- Standard wire diameter: 0.15 mm
- 25 m coils
- Insulation voltage: 450 V
- Working temperature: up to 70°C

Part No.	Description	Section mm ²	mm	Number of Wire	Nominal Current A		 Kg
503400	RTCBI 15-10	10	7	560	75	25 m	0.12
503410	RTCBI 15-16	16	8	900	120	25 m	0.18
503420	RTCBI 15-25	25	9.5	1416	150	25 m	0.25
503430	RTCBI 15-30	30	10	1680	180	25 m	0.35
503440	RTCBI 15-50	50	12.5	2820	250	25 m	0.58

On Request Special Manufacturing:

- Tubular braids up to 60 mm diameter maximum
- Flat or round copper braids up to 400 mm² maximum
- Insulation 105°C



Make Your Own Braided Connections

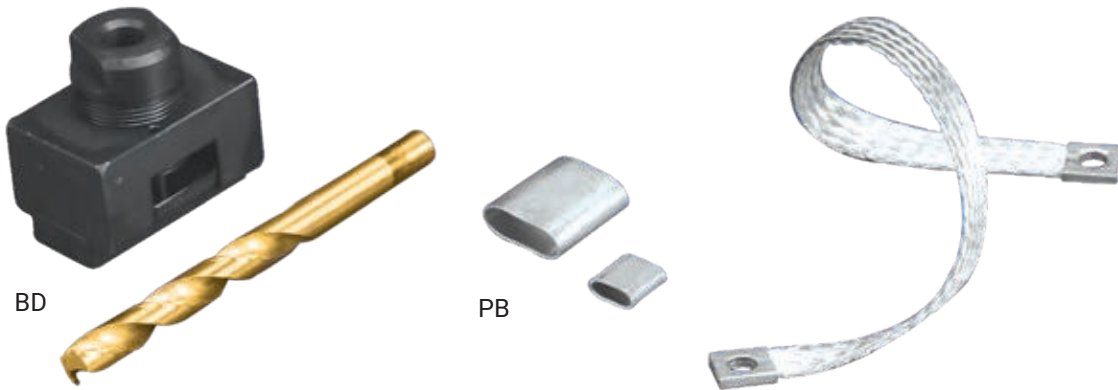

BD CRIMP AND DRILL TOOL

- This tool has been developed by nVent ERIFLEX specifically for crimping and drilling of braid terminals. Guide and specially adapted drill bit included

Part No.	Description	For Flat	Ø Drill Bit	Bolt		Kg
558610	BD 16	FTCB or FRCB 15-16	6.5	M6	1	0.653
558640	BD 16-8.5	FTCB or FRCB 15-16	8.5	M8	1	0.653
558620	BD 25	FTCB or FRCB 15-25	11	M10	1	0.678
558630	BD 50	FTCB or FRCB 15-50	12.5	M126	1	0.712

HCT 3-4 CRIMPING TOOL FOR HYDRAULIC WORK CENTER

- This package allows to crimp lugs PB16, PB25 and PB50 on braids with the hydraulic nVent ERIFLEX Puncher

Part No.	Description		Kg
545980	HCT 3-4	1	1.850

PB LUGS FOR FLAT BRAIDS (FTCB OR FCRB)

- In tinned annealed copper

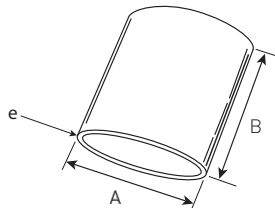

Part No.	Description	For Flat	A	B	e		Kg
557180	PB 16	FTCB or FRCB 15-16	16	15	1	100	0.004
557190	PB 25	FTCB or FRCB 15-25	22	25	1	100	0.010
557380	PB 50	FTCB or FRCB 15-50	30	30	1	100	0.017

ABOUT ELECTROMAGNETIC COMPATIBILITY

In an environment where electromagnetic disturbances are more and more numerous, the ElectroMagnetic Compatibility (EMC) is increasingly important in the design and building of electrical panels.

In order to avoid stray currents, it is necessary that all the metallic framework, inside the panel or outside, is at the same electrical potential. Thus, it is essential to link all these metal parts with connections presenting a low impedance at High Frequency (H.F.).

Connections with cables are not efficient. Only short and flat conductors are. Their H.F. impedances are 10 times lower than the wire impedances.

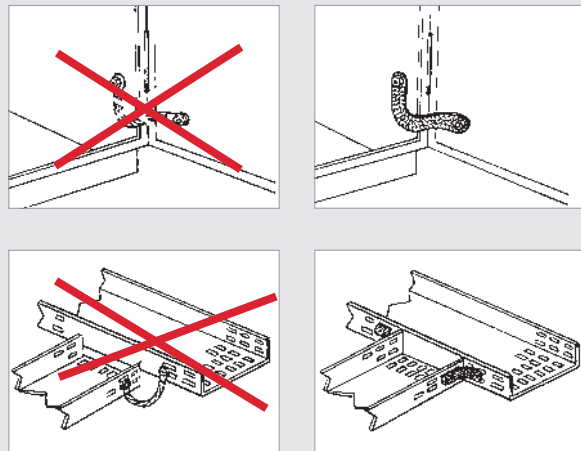

Made to Order Solutions (MTO)

FLEXIBAR CUSTOM SOLUTIONS (MADE TO ORDER)

nVent ERIFLEX can provide preformed Flexibar configurations to your drawing specifications. Flexibar can be cut, punched, twisted or bent to address your most challenging panelboard designs and production scheduling requirements. Give nVent ERIFLEX your low voltage connection challenges!

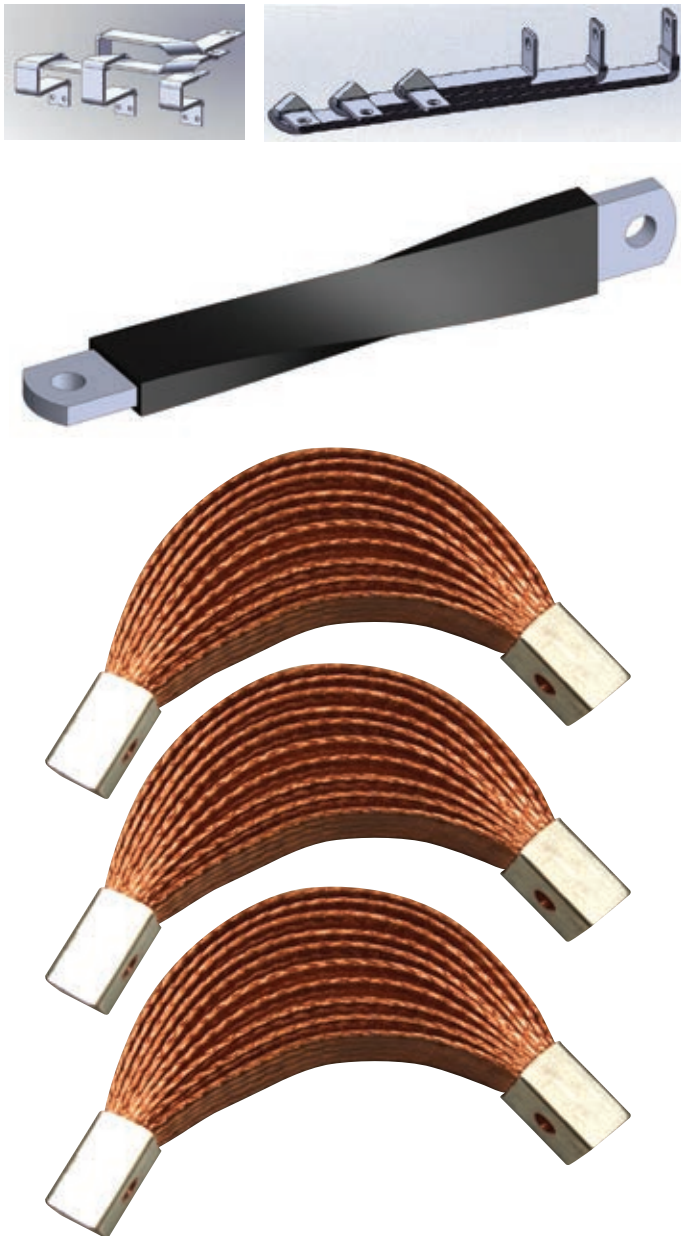

BRAIDED CONDUCTORS CUSTOM SOLUTIONS (MADE TO ORDER)

nVent ERIFLEX brand of copper braids can be made to custom lengths, widths, thicknesses and hole patterns; with PVC or TPE (Advanced) insulation; in flat or tubular shapes; using copper or stainless steel wire; in continuous coils; or with soldered studs or crimped lugs. Let nVent ERIFLEX solve your design and production scheduling challenges.

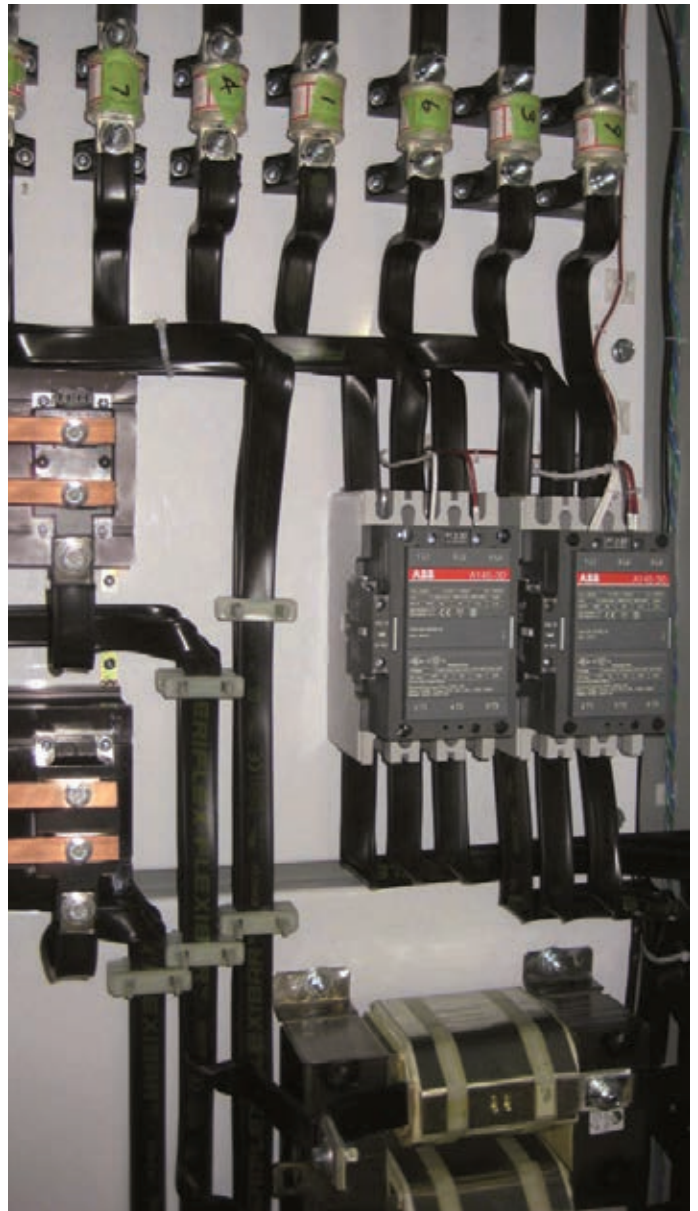

Made to Order Solutions (MTO)

CUSTOM SOLUTIONS (MADE TO ORDER) - CHECK LIST

Summary of the information we need for custom design work. Please photocopy this page and complete it by providing the information you know and sending to your local nVent ERIFLEX customer service representative. (Sections can be left blank)

Electrical Function:

Earthing/grounding conductor.....
Power conductor.....
Nominal current..... _____ A
Alternating or direct current..... _____
Nominal voltage..... _____ V
Insulation specification (if require).....
.....

Material:

Red/plain copper.....
Tinned copper.....
Stainless steel.....
Aluminum.....
Other.....

Environment:

Ambient temperature..... _____ C°
Operating temperature..... _____ C°
Conductor maximum temperature..... _____ C°
Humidity (dry/average/moist)..... %HR

EXTREMITY/TERMINAL DIMENSIONS:

Indicate your dimensions on the proposed terminal drawing or make a sketch showing your needs.

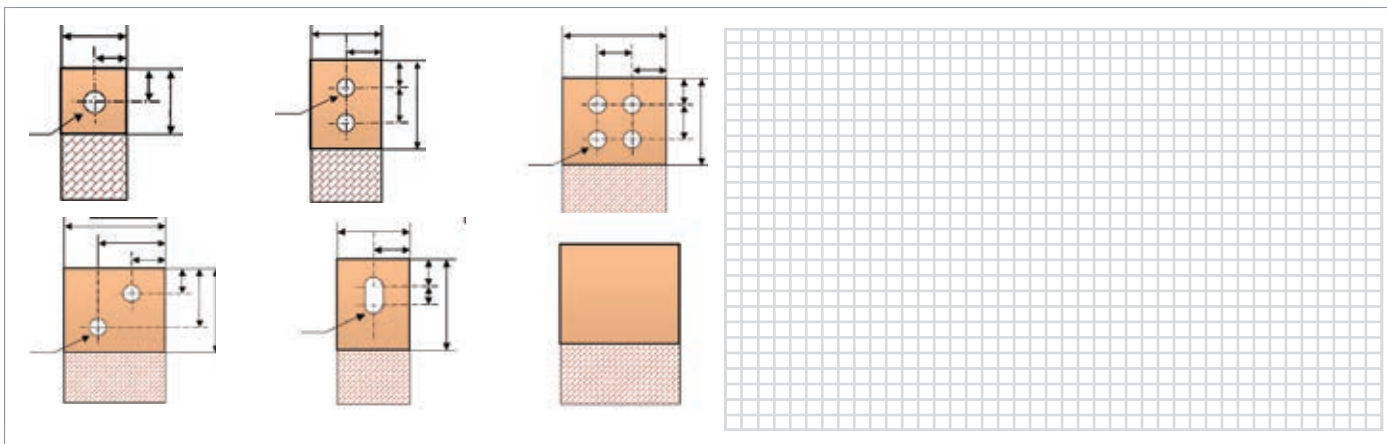

This section contains six technical drawings of terminal cross-sections. The first three show terminals with one, two, and three circular conductors respectively. The next two show terminals with a central oval conductor and a surrounding rectangular conductor. The final drawing is a simple rectangular terminal. To the right of these drawings is a large rectangular grid for sketching dimensions.

Conductor Dimensions:

Availability: Drawing Specification Samples
Cross Section _____ mm²
Flat or Round Section _____
Width of the Conductor _____ mm
Thickness of the Conductor _____ mm
Length of the Conductor _____ mm
Quantity _____

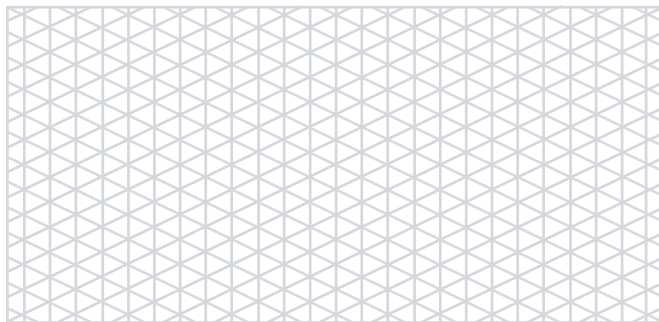

Contact/Requested by:

Company _____ E-mail address _____
Contact Name _____ Address (City & Country) _____
Phone Number _____

Cross Reference List

Part Number	Page	Part Number	Page	Part Number	Page
534001	13	534041	13	534024	15
534004	13	534046	13	534025	15
534006	13	534049	13	534026*	15
534005	13	534042	13	534027*	15
534002	13	534050	13	534028*	15
534010	13	534047	13	534029*	15
534007	13	534051	13	534030	15
534016	13	534048	13	534031	15
534011	13	534055	13	534032	15
534008	13	534052	13	534033*	15
534017	13	534056	13	534034*	15
534012	13	534053	13	534035*	15
534023	13	534057	13	534036*	15
534013	13	534058	13	534037	15
534018	13	534059	13	534038*	15
534030	13	534060	13	534039*	15
534024	13	534000	15	534040*	15
534014	13	534001	15	534041*	15
534019	13	534002	15	534042*	15
534020	13	534003	15	534044*	15
534025	13	534004	15	534045*	15
534031	13	534005	15	534046*	15
534026	13	534006	15	534047*	15
534015	13	534007	15	534048*	15
534021	13	534008	15	534049*	15
534032	13	534009	15	534050*	15
534027	13	534010	15	534051*	15
534037	13	534011	15	534052*	15
534022	13	534012	15	534053*	15
534033	13	534013*	15	534055*	15
534038	13	534014*	15	534056*	15
534028	13	534015*	15	534057*	15
534034	13	534016	15	534058*	15
534039	13	534017	15	534059*	15
534029	13	534018	15	534060*	15
534035	13	534019*	15	566490	17
534044	13	534020*	15	566500	17
534040	13	534021*	15	566510	17
534036	13	534022*	15	566520	17
534045	13	534023	15	566550	17

Cross Reference List

Part Number	Page	Part Number	Page	Part Number	Page
566560	17	553110	20	534512	27
566570	17	553120	20	534513	27
566580	17	561210	21	534414	27
566590	17	561220	21	534415	27
566630	17	553405	21	534416	27
566640	17	553400	21	534417	27
566650	17	553410	21	534418	27
566660	17	553510	21	534419	27
566670	17	553520	21	534420	27
566720	17	553505	21	534421	27
566730	17	553430	21	534422	27
566750	17	553440	21	534423	27
566780	17	553530	21	534424	27
566800	17	553540	21	534425	27
566810	17	534400	27	534426	27
553590	18	534401	27	534427	27
541774	18	534402	27	534428	27
541775	18	534403	27	534429	27
541776	18	534404	27	534430	27
553550	19	534405	27	534431	27
553560	19	534406	27	534432	27
553570	19	534500	27	534433	27
553580	19	534501	27	534434	27
553370	19	534502	27	534435	27
553380	19	534503	27	534436	27
553020	20	534504	27	534437	27
553030	20	534505	27	534438	27
553040	20	534506	27	534439	27
553050	20	534407	27	534440	27
553060	20	534408	27	534441	27
553070	20	534409	27	534442	27
568700	20	534410	27	534443	27
568730	20	534411	27	534444	27
553200	20	534412	27	534445	27
553210	20	534413	27	534446	27
553220	20	534507	27	534514	31
553230	20	534508	27	534515	31
553250	20	534509	27	534516	31
553260	20	534510	27	534517	31
553100	20	534511	27	534518	31

Cross Reference List

Part Number	Page	Part Number	Page	Part Number	Page
534519	31	556660	36	563470	36
534520	31	556940	36	563480	36
534521	31	556670	36	563490	36
534522	31	556680	36	563500	36
534523	31	563340	36	563510	36
534524	31	556690	36	563520	36
534525	31	563430	36	563530	36
534526	31	556700	36	563601	38
534527	31	556710	36	563602	38
534528	31	556950	36	563603	38
534529	31	556720	36	563604	38
534530	31	556730	36	563605	38
534531	31	556740	36	563606	38
558584	33	556750	36	563607	38
558586	33	556760	36	563608	38
558587	33	556960	36	563609	38
558588	33	556770	36	563611	38
558589	33	556780	36	563612	38
558591	33	556790	36	563613	38
558592	33	556800	36	563614	38
558593	33	565000	36	563615	38
558594	33	556810	36	563616	38
558595	33	556970	36	563617	38
553550	34	556820	36	563618	38
553560	34	556830	36	563619	38
556900	35	563350	36	563621	38
556910	35	556840	36	563622	38
556920	35	563440	36	554277	40
556600	36	563360	36	554278	40
563410	36	563370	36	554279	40
556930	36	556850	36	554280	40
556610	36	563380	36	554282	40
563540	36	556860	36	554286	40
556620	36	563390	36	554299	40
563550	36	563400	36	554300	40
556630	36	556980	36	554301	40
563300	36	563560	36	554302	40
556640	36	563450	36	554304	40
556650	36	563460	36	554308	40
563320	36	563420	36	554321	40

Cross Reference List

Part Number	Page
554322	40
554323	40
554324	40
554326	40
554330	40
554343	40
554344	40
554345	40
554346	40
554348	40
554352	40
554365	40
554366	40
554367	40
554368	40
554370	40
554374	40
554378	40
554384	40
554386B	42
554401B	42
554398B	42
554403B	42
554405B	42
554407B	42
554427B	42
554428B	42
554429B	42
554409B	42
554412B	42
554416B	42
554421B	42
554414B	42
554418B	42
554423B	42
554397B	42
554402B	42
554399B	42
554404B	42
554406B	42

Part Number	Page
554408B	42
554411B	42
554413B	42
554417B	42
554422B	42
554388B	42
554415B	42
554419B	42
554424B	42
564000	43
564050	43
564010	43
564100	43
564150	43
564200	43
564250	43
564300	43
564400	43
564500	43
564600	43
564700	43
564800	43
564900	43
564030	43
566030	44
566040	44
566050	44
566060	44
566070	44
557200	45
557210	45
557220	45
557230	45
557240	45
557250	45
557260	45
557270	45
557280	45
557290	45
557300	45

Part Number	Page
557310	45
557320	45
557330	45
557350	45
557030	45
557040	45
557050	45
557060	45
557080	45
557090	45
557100	45
557120	45
557130	45
557150	45
510300	45
510310	45
510340	45
503510	45
503520	45
503530	45
503540	45
557160	45
557170	45
557390	45
557600	46
557610	46
557620	46
557630	46
557640	46
557650	46
557660	46
557670	46
557680	46
503700	46
503710	46
503720	46
510100	46
510110	46
510120	46
510130	46

Cross Reference List

Part Number	Page
510140	46
510150	46
510160	46
510170	46
510180	46
504690	46
557400	46
557420	46
557430	46
557440	46
557450	46
557460	46
557470	46
510500	47
510510	47
503400	47
503410	47
503420	47
503430	47
503440	47
558610	48
558640	48
558620	48
558630	48
545980	48
557180	48
557190	48
557380	48

OTHER LITERATURE

DISTRIBUTION BLOCKS, POWER BLOCKS AND DISTRIBUTION TERMINAL



HYDRAULIC & MANUAL TOOLS

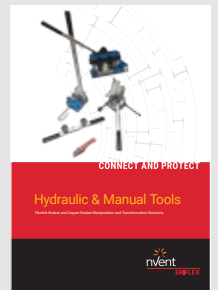

SOLUTIONS FOR ELECTRICAL POWER & EARTH CONNECTIONS

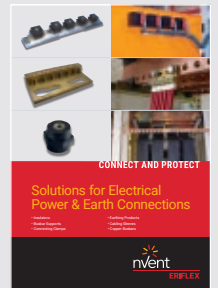

READY-TO-USE POWER CONDUCTOR: IBS & IBSB ADVANCED TECHNICAL GUIDE



NVENT ERIFLEX FLEXIBAR TECHNICAL HANDBOOK

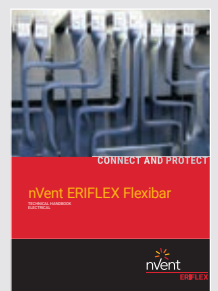

Our powerful portfolio of brands:

CADDY ERICO HOFFMAN RAYCHEM SCHROFF TRACER



[nVent.com/ERIFLEX](https://www.nVent.com/ERIFLEX)

©2020 nVent. All nVent marks and logos are owned or licensed by nVent Services GmbH or its affiliates. All other trademarks are the property of their respective owners. nVent reserves the right to change specifications without notice.

ERIFLEX-CAT-P1300C-FlexibleConductor-USEN-2003